

Installation Instructions

Original Instructions



Allen-Bradley

by ROCKWELL AUTOMATION

FLEX I/O DC Input, Output, and Input/Output Analog Modules

Catalog Numbers 1794-IE12, 1794-IE12K, 1794-OE12, 1794-IE8XOE4, 1794-IE8XOE4K

Topic	Page
Summary of Changes	1
Module Overview	4
Install Your Module	4
Wiring Your Module	5
Configure Your Module	8
Specifications	10
Additional Resources	12

Summary of Changes

This publication contains the following new or updated information. This list includes substantive updates only and is not intended to reflect all changes.

Topic	Page
Updated Certifications	12
Added Additional Resources	12



ATTENTION: Read this document and the documents listed in the Additional Resources section about installation, configuration and operation of this equipment before you install, configure, operate or maintain this product. Users are required to familiarize themselves with installation and wiring instructions in addition to requirements of all applicable codes, laws, and standards.

Activities including installation, adjustments, putting into service, use, assembly, disassembly, and maintenance are required to be carried out by suitably trained personnel in accordance with applicable code of practice. If this equipment is used in a manner not specified by the manufacturer, the protection provided by the equipment may be impaired.

注意：在安装、配置、操作和维护本产品前，请阅读本文档以及“其他资源”部分列出的有关设备安装、配置和操作的相应文档。除了所有适用规范、法律和标准的相关要求之外，用户还必须熟悉安装和接线说明。

安装、调整、投运、使用、组装、拆卸和维护等各项操作必须由经过适当训练的专业人员按照适用的操作规范实施。

如果未按照制造商指定的方式使用该设备，则可能会损害设备提供的保护。

ATENCIÓN: Antes de instalar, configurar, poner en funcionamiento o realizar el mantenimiento de este producto, lea este documento y los documentos listados en la sección Recursos adicionales acerca de la instalación, configuración y operación de este equipo. Los usuarios deben familiarizarse con las instrucciones de instalación y cableado y con los requisitos de todos los códigos, leyes y estándares vigentes.

El personal debidamente capacitado debe realizar las actividades relacionadas a la instalación, ajustes, puesta en servicio, uso, ensamble, desensamble y mantenimiento de conformidad con el código de práctica aplicable. Si este equipo se usa de una manera no especificada por el fabricante, la protección provista por el equipo puede resultar afectada.

ATENÇÃO: Leia este e os demais documentos sobre instalação, configuração e operação do equipamento que estão na seção Recursos adicionais antes de instalar, configurar, operar ou manter este produto. Os usuários devem se familiarizar com as instruções de instalação e fiação além das especificações para todos os códigos, leis e normas aplicáveis.

É necessário que as atividades, incluindo instalação, ajustes, colocação em serviço, utilização, montagem, desmontagem e manutenção sejam realizadas por pessoal qualificado e especializado, de acordo com o código de prática aplicável.

Caso este equipamento seja utilizado de maneira não estabelecida pelo fabricante, a proteção fornecida pelo equipamento pode ficar prejudicada.

ВНИМАНИЕ: Перед тем как устанавливать, настраивать, эксплуатировать или обслуживать данное оборудование, прочитайте этот документ и документы, перечисленные в разделе «Дополнительные ресурсы». В этих документах изложены сведения об установке, настройке и эксплуатации данного оборудования. Пользователи обязаны ознакомиться с инструкциями по установке и прокладке соединений, а также с требованиями всех применимых норм, законов и стандартов.

Все действия, включая установку, наладку, ввод в эксплуатацию, использование, сборку, разборку и техническое обслуживание, должны выполняться обученным персоналом в соответствии с применимыми нормами и правилами.

Если оборудование используется не предусмотренным производителем образом, защита оборудования может быть нарушена.

注意：本製品を設置、構成、稼働または保守する前に、本書および本機器の設置、設定、操作についての参考資料の該当箇所に記載されている文書に目を通してください。ユーザは、すべての該当する条例、法律、規格の要件に加えて、設置および配線の手順に習熟している必要があります。

設置調整、運転の開始、使用、組立て、解体、保守を含む諸作業は、該当する実施規則に従って訓練を受けた適切な作業員が実行する必要があります。

本機器が製造メーカーにより指定されていない方法で使用されている場合、機器により提供されている保護が損なわれる恐れがあります。

ACHTUNG: Lesen Sie dieses Dokument und die im Abschnitt „Weitere Informationen“ aufgeführten Dokumente, die Informationen zu Installation, Konfiguration und Bedienung dieses Produkts enthalten, bevor Sie dieses Produkt installieren, konfigurieren, bedienen oder warten. Anwender müssen sich neben den Bestimmungen aller anwendbaren Vorschriften, Gesetze und Normen zusätzlich mit den Installations- und Verdrahtungsanweisungen vertraut machen.

Arbeiten im Rahmen der Installation, Anpassung, Inbetriebnahme, Verwendung, Montage, Demontage oder Instandhaltung dürfen nur durch ausreichend geschulte Mitarbeiter und in Übereinstimmung mit den anwendbaren Ausführungsvorschriften vorgenommen werden.

Wenn das Gerät in einer Weise verwendet wird, die vom Hersteller nicht vorgesehen ist, kann die Schutzfunktion beeinträchtigt sein.

ATTENTION : Lisez ce document et les documents listés dans la section Ressources complémentaires relatifs à l'installation, la configuration et le fonctionnement de cet équipement avant d'installer, configurer, utiliser ou entretenir ce produit. Les utilisateurs doivent se familiariser avec les instructions d'installation et de câblage en plus des exigences relatives aux codes, lois et normes en vigueur.

Les activités relatives à l'installation, le réglage, la mise en service, l'utilisation, l'assemblage, le démontage et l'entretien doivent être réalisées par des personnes formées selon le code de pratique en vigueur.

Si cet équipement est utilisé d'une façon qui n'a pas été définie par le fabricant, la protection fournie par l'équipement peut être compromise.

주의：본 제품 설치, 설정, 작동 또는 유지 보수하기 전에 본 문서를 포함하여 설치, 설정 및 작동에 관한 참고 자료 섹션의 문서들을 반드시 읽고 숙지하십시오. 사용자는 모든 관련 규정, 법규 및 표준에서 요구하는 사항에 대해 반드시 설치 및 배선 지침을 숙지해야 합니다.

설치, 조정, 가동, 사용, 조립, 분해, 유지보수 등 모든 작업은 관련 규정에 따라 적절한 교육을 받은 사용자를 통해서만 수행해야 합니다.

본 장비를 제조사가 명시하지 않은 방법으로 사용하면 장비의 보호 기능이 손상될 수 있습니다.

ATTENZIONE Prima di installare, configurare ed utilizzare il prodotto, o effettuare interventi di manutenzione su di esso, leggere il presente documento ed i documenti elencati nella sezione "Altre risorse", riguardanti l'installazione, la configurazione ed il funzionamento dell'apparecchiatura. Gli utenti devono leggere e comprendere le istruzioni di installazione e cablaggio, oltre ai requisiti previsti dalle leggi, codici e standard applicabili.

Le attività come installazione, regolazioni, utilizzo, assemblaggio, disassemblaggio e manutenzione devono essere svolte da personale adeguatamente addestrato, nel rispetto delle procedure previste.

Qualora l'apparecchio venga utilizzato con modalità diverse da quanto previsto dal produttore, la sua funzione di protezione potrebbe venire compromessa.

DIKKAT: Bu ürünün kurulumu, yapılandırılması, işletilmesi veya bakımı öncesinde bu dokümanı ve bu ekipmanın kurulumu, yapılandırılması ve işletimi ile ilgili ilave Kaynaklar bölümünde yer listelenmiş dokümanları okuyun. Kullanıcılar yürürlükteki tüm yönetmelikler, yasalar ve standartların gereksinimlerine ek olarak kurulum ve kablolarla talimatlarını da öğrenmek zorundadır.

Kurulum, ayarlama, hizmete alma, kullanma, parçaları birleştirme, parçaları sökme ve bakım gibi aktiviteler sadece uygun eğitimli almış kişiler tarafından yürürlükteki uygulama yönetmeliklerine uygun şekilde yapılabilir.

Bu ekipman üretici tarafından belirlenmiş amacın dışında kullanılırsa, ekipman tarafından sağlanan koruma bozulabilir.

注意事項：在安装、設定、操作或維護本產品前，請先閱讀此文件以及列於「其他資源」章節中有關安裝、設定與操作此設備的文件。使用者必須熟悉安裝和配線指示，並符合所有法規、法律和標準要求。

包括安裝、調整、交付使用、使用、組裝、拆卸和維護等動作都必須交由已經過適當訓練的人員進行，以符合適用的實作法規。

如果將設備用於非製造商指定的用途時，可能會造成設備所提供的保護功能受損。

POZOR: Než začnete instalovat, konfigurovat či provázovat tento výrobek nebo provádět jeho údržbu, přečtěte si tento dokument a dokumenty uvedené v části Dodatečné zdroje ohledně instalace, konfigurace a provozu tohoto zařízení. Uživatelé se musejí vedle požadavků všech relevantních vyhlásek, zákonů a norem nutně seznámit také s pokyny pro instalaci a elektrické zapojení.

Činnosti zahrnující instalaci, nastavení, uvedení do provozu, užívání, montáž, demontáž a údržbu musí vykonávat vhodné proškolený personál v souladu s příslušnými prováděcími předpisy.

Pokud se toto zařízení používá způsobem neodpovídajícím specifikaci výrobce, může být narušena ochrana, kterou toto zařízení poskytuje.

UWAGA: Przed instalacją, konfiguracją, użytkowaniem lub konserwacją tego produktu należy przeczytać niniejszy dokument oraz wszystkie dokumenty wymienione w sekcji Dodatkowe źródła omawiające instalację, konfigurację i procedury użytkowania tego urządzenia. Użytkownicy mają obowiązek zapoznać się z instrukcjami dotyczącymi instalacji oraz oprzewodowania, jak również z obowiązującymi kodeksami, prawem i normami.

Działania obejmujące instalację, regulację, przekazanie do użytkowania, użytkowanie, montaż, demontaż oraz konserwację muszą być wykonywane przez odpowiednio przeszkolony personel zgodnie z obowiązującym kodeksem postępowania.

Jeśli urządzenie jest użytkowane w sposób inny niż określony przez producenta, zabezpieczenie zapewniane przez urządzenie może zostać ograniczone.

OB! Läs detta dokument samt dokumentet, som står listat i avsnittet Övriga resurser, om installation, konfigurering och drift av denna utrustning innan du installerar, konfigurerar eller börjar använda eller utföra underhållsarbete på produkten. Användare måste bekanta sig med instruktioner för installation och kabeldragning, förutom krav enligt gällande koder, lagar och standarder.

Åtgärder som installation, justering, service, användning, montering, demontering och underhållsarbete måste utföras av personal med lämplig utbildning enligt lämpligt bruk.

Om denna utrustning används på ett sätt som inte anges av tillverkaren kan det hända att utrustningens skyddsanordningar försätts ur funktion.

LET OP: Lees dit document en de documenten die genoemd worden in de paragraaf Aanvullende informatie over de installatie, configuratie en bediening van deze apparatuur voordat u dit product installeert, configureert, bedient of onderhoudt. Gebruikers moeten zich vertrouwd maken met de installatie en de bedringsinstructies, naast de vereisten van alle toepasselijke regels, wetten en normen.

Activiteiten zoals het installeren, afstellen, in gebruik stellen, gebruiken, monteren, demonteren en het uitvoeren van onderhoud mogen uitsluitend worden uitgevoerd door hiervoor opgeleid personeel en in overeenstemming met de geldende praktijkregels.

Indien de apparatuur wordt gebruikt op een wijze die niet is gespecificeerd door de fabrikant, dan bestaat het gevaar dat de beveiliging van de apparatuur niet goed werkt.

Environment and Enclosure



ATTENTION: This equipment is intended for use in a Pollution Degree 2 industrial environment, in overvoltage Category II applications (as defined in EN/IEC 60664-1), at altitudes up to 2000 m (6562 ft) without derating. This equipment is not intended for use in residential environments and may not provide adequate protection to radio communication services in such environments.

This equipment is supplied as open-type equipment for indoor use. It must be mounted within an enclosure that is suitably designed for those specific environmental conditions that will be present and appropriately designed to prevent personal injury resulting from accessibility to live parts. The enclosure must have suitable flame-retardant properties to prevent or minimize the spread of flame, complying with a flame spread rating of 5VA or be approved for the application if nonmetallic. The interior of the enclosure must be accessible only by the use of a tool. Subsequent sections of this publication may contain more information regarding specific enclosure type ratings that are required to comply with certain product safety certifications.

In addition to this publication, see the following:

- Industrial Automation Wiring and Grounding Guidelines, publication [1770-4.1](#), for more installation requirements.
 - NEMA Standard 250 and EN/IEC 60529, as applicable, for explanations of the degrees of protection provided by enclosures.
-

Prevent Electrostatic Discharge



ATTENTION: This equipment is sensitive to electrostatic discharge, which can cause internal damage and affect normal operation. Follow these guidelines when you handle this equipment:

- Touch a grounded object to discharge potential static.
 - Wear an approved grounding wriststrap.
 - Do not touch connectors or pins on component boards.
 - Do not touch circuit components inside the equipment.
 - Use a static-safe workstation, if available.
 - Store the equipment in appropriate static-safe packaging when not in use.
-



ATTENTION: This product is grounded through the DIN rail to chassis ground. Use zinc-plated chromate-passivated steel DIN rail to assure proper grounding. The use of other DIN rail materials (for example, aluminum or plastic) that can corrode, oxidize, or are poor conductors, can result in improper or intermittent grounding. Secure DIN rail to mounting surface approximately every 200 mm (7.8 in.) and use end-anchors appropriately. Be sure to ground the DIN rail properly. See the Industrial Automation Wiring and Grounding Guidelines, Rockwell Automation publication [1770-4.1](#), for more information.



ATTENTION: To reduce susceptibility to noise, power analog modules and digital modules from separate power supplies.

Special Conditions for Safe Use

ATTENTION:

- If this equipment is used in a manner not specified by the manufacturer, the protection provided by the equipment may be impaired.
- Read this document and the documents listed in the Additional Resources section about installation, configuration, and operation of this equipment before you install, configure, operate, or maintain this product. Users are required to familiarize themselves with installation and wiring instructions in addition to requirements of all applicable codes, laws, and standards.
- Installation, adjustments, putting into service, use, assembly, disassembly, and maintenance are required to be carried out by suitably trained personnel in accordance with applicable code of practice.

In case of malfunction or damage, no attempts at repair should be made. The module should be returned to the manufacturer for repair. Do not dismantle the module.



WARNING: When you insert or remove the module while backplane power is on, an electric arc can occur. This could cause an explosion in hazardous location installations.

Be sure that power is removed or the area is nonhazardous before proceeding. Repeated electric arcing causes excessive wear to contacts on both the module and its mating connector. Worn contacts may create electrical resistance that can affect module operation.





ATTENTION: If you connect or disconnect wiring while the field side power is on, an electric arc can occur. This could cause an explosion in hazardous location installations. Be sure that power is removed or the area is nonhazardous before proceeding.



ATTENTION: Do not remove or replace a Terminal Base unit while power is applied. Interruption of the backplane can result in unintentional operation or machine motion.

North American Hazardous Location Approval

<p>The following information applies when operating this equipment in hazardous locations.</p>	<p>Informations sur l'utilisation de cet équipement en environnements dangereux.</p>
<p>Products marked "CL I, DIV 2, GP A, B, C, D" are suitable for use in Class I Division 2 Groups A, B, C, D, Hazardous Locations and nonhazardous locations only. Each product is supplied with markings on the rating nameplate indicating the hazardous location temperature code. When combining products within a system, the most adverse temperature code (lowest "T" number) may be used to help determine the overall temperature code of the system. Combinations of equipment in your system are subject to investigation by the local Authority Having Jurisdiction at the time of installation.</p>	<p>Les produits marqués "CL I, DIV 2, GP A, B, C, D" ne conviennent qu'à une utilisation en environnements de Classe I Division 2 Groupes A, B, C, D dangereux et non dangereux. Chaque produit est livré avec des marquages sur sa plaque d'identification qui indiquent le code de température pour les environnements dangereux. Lorsque plusieurs produits sont combinés dans un système, le code de température le plus défavorable (code de température le plus faible) peut être utilisé pour déterminer le code de température global du système. Les combinaisons d'équipements dans le système sont sujettes à inspection par les autorités locales qualifiées au moment de l'installation.</p>
<p> WARNING: Explosion Hazard -</p> <ul style="list-style-type: none"> Do not disconnect equipment unless power has been removed or the area is known to be nonhazardous. Do not disconnect connections to this equipment unless power has been removed or the area is known to be nonhazardous. Secure any external connections that mate to this equipment by using screws, sliding latches, threaded connectors, or other means provided with this product. Substitution of components may impair suitability for Class I Division 2. If this product contains batteries, they must only be changed in an area known to be nonhazardous. 	<p> AVERTISSEMENT: Risque d'Explosion -</p> <ul style="list-style-type: none"> Couper le courant ou s'assurer que l'environnement est classé non dangereux avant de débrancher l'équipement. Couper le courant ou s'assurer que l'environnement est classé non dangereux avant de débrancher les connecteurs. Fixer tous les connecteurs externes reliés à cet équipement à l'aide de vis, loquets coulissants, connecteurs filetés ou autres moyens fournis avec ce produit. La substitution de composants peut rendre cet équipement inadapté à une utilisation en environnement de Classe I Division 2. S'assurer que l'environnement est classé non dangereux avant de changer les piles.



WARNING: When used in a Class I Division 2, hazardous location, this equipment must be mounted in a suitable enclosure with proper wiring method that complies with the governing electrical codes.

Module Overview

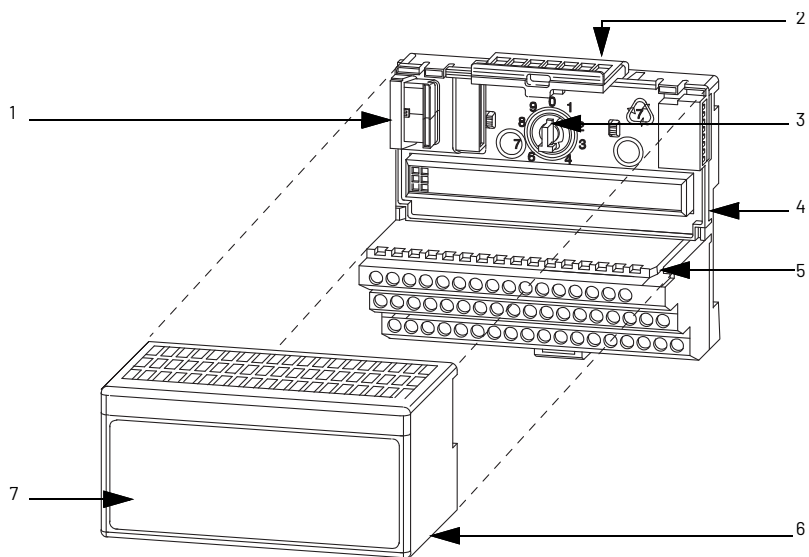

	Description		Description
1	Flexbus connector	5	Groove
2	Latching mechanism	6	Alignment bar
3	Keyswitch	7	Module
4	Terminal base		

Install Your Module

The FLEX™ I/O analog input/output modules mount on a 1794-TB3G, 1794-TB3GS, 1794-TB3GK, or 1794-TB3GSK terminal base.

- Rotate the keyswitch (3) on the terminal base (4) clockwise to position 3 (1794-IE12 and 1794-IE12K), 4 (1794-OE12), or 5 (1794-IE8XOE4 and 1794-IE8XOE4K) as required.
- Make certain the Flexbus connector (1) is pushed all the way to the left to connect with the neighboring terminal base/adaptor. **You cannot install the module unless the connector is fully extended.**
- Make sure the pins on the bottom of the module are straight so they align properly with the connector in the terminal base.

4. Position the module (7) with its alignment bar (6) aligned with the groove (5) on the terminal base.
5. Press firmly and evenly to seat the module in the terminal base unit. The module is seated when the latching mechanism (2) is locked into the module.



ATTENTION: During mounting of all devices, be sure that all debris (such as metal chips, and wire strands) is kept from falling into the module. Debris that falls into the module could cause damage on power up.

Wiring Your Module

Connect the wiring for the 1794-TB3G, 1794-TB3GS, 1794-TB3GK, and 1794-TB3GSK terminal bases as shown in [Figure 1](#).

Figure 1 - 1794-TB3G, 1794-TB3GS, 1794-TB3GK, and 1794-TB3GSK Terminal Base Wiring

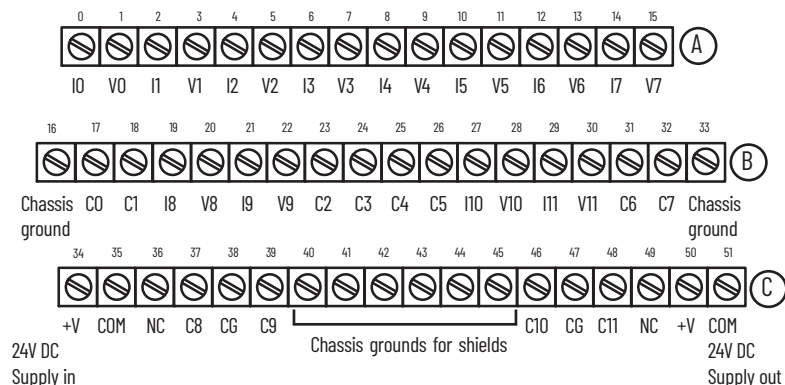

I = Current
 V = Voltage
 C-0...C-11 = Returns for I or V connections 0...11
 +24V DC = Terminals C-34 and C-50
 COM = Terminals C-35 and C-51
 Chassis ground (CG) = Terminals B-16, B-33, C-38, C-40...C-45, C-47
 NC = No connection
 For daisy chaining: Supply in - C-34 (+) and C-35 (-),
 Supply out - C-50 (+) and C-51 (-)

(1794-TB3G shown)



ATTENTION: To reduce susceptibility to noise, power analog modules and digital modules from separate power supplies. Do not exceed a length of 10 m (33 ft) for DC power or analog I/O cabling.



ATTENTION: Do not daisy-chain power or ground from this terminal base unit to any AC or DC digital module terminal base units.



ATTENTION: Do not exceed a length of 10 m (33 ft) for signal cabling.

Table 1 - Wiring Connections for the 1794-IE12 and 1794-IE12K Analog Input Module

Channel	Signal Type	Label Marking	1794-TB3G, 1794-TB3GS, 1794-TB3GK, 1794-TB3GSK	
			Input	Common Terminal
Input 0	Current	I0	A-0	B-17
	Voltage	V0	A-1	
Input 1	Current	I1	A-2	B-18
	Voltage	V1	A-3	
Input 2	Current	I2	A-4	B-23
	Voltage	V2	A-5	
Input 3	Current	I3	A-6	B-24
	Voltage	V3	A-7	
Input 4	Current	I4	A-8	B-25
	Voltage	V4	A-9	

Table 1 - Wiring Connections for the 1794-IE12 and 1794-IE12K Analog Input Module (Continued)

Channel	Signal Type	Label Marking	1794-TB3G, 1794-TB3GS, 1794-TB3GK, 1794-TB3GSK	
			Input	Common Terminal
Input 5	Current	I5	A-10	B-26
	Voltage	V5	A-11	
Input 6	Current	I6	A-12	B-31
	Voltage	V6	A-13	
Input 7	Current	I7	A-14	B-32
	Voltage	V7	A-15	
Input 8	Current	I8	B-19	C-37
	Voltage	V8	B-20	
Input 9	Current	I9	B-21	C-39
	Voltage	V9	B-22	
Input 10	Current	I10	B-27	C-46
	Voltage	V10	B-28	
Input 11	Current	I11	B-29	C-48
	Voltage	V11	B-30	
+V DC Power	Terminals C-34 and C-50 are internally connected in the terminal base unit.			
-V DC Common	Terminals C-35 and C-51 are internally connected in the terminal base unit.			
Chassis ground	Terminals B-16, B-33, C-38, C-40...C-45, and C-47 are internally connected to the chassis ground.			



ATTENTION: Connect only one current or voltage signal per channel. Do not connect both current and voltage on one channel.

Table 2 - Wiring Connections for the 1794-OE12 Analog Output Module

Channel	Signal Type	Label Marking	1794-TB3G, 1794-TB3GS, 1794-TB3GK, 1794-TB3GSK	
			Output	Common Terminal
Output 0	Current	I0	A-0	B-17
	Voltage	V0	A-1	
Output 1	Current	I1	A-2	B-18
	Voltage	V1	A-3	
Output 2	Current	I2	A-4	B-23
	Voltage	V2	A-5	
Output 3	Current	I3	A-6	B-24
	Voltage	V3	A-7	
Output 4	Current	I4	A-8	B-25
	Voltage	V4	A-9	
Output 5	Current	I5	A-10	B-26
	Voltage	V5	A-11	
Output 6	Current	I6	A-12	B-31
	Voltage	V6	A-13	
Output 7	Current	I7	A-14	B-32
	Voltage	V7	A-15	
Output 8	Current	I8	B-19	C-37
	Voltage	V8	B-20	
Output 9	Current	I9	B-21	C-39
	Voltage	V9	B-22	
Output 10	Current	I10	B-27	C-46
	Voltage	V10	B-28	
Output 11	Current	I11	B-29	C-48
	Voltage	V11	B-30	
+V DC Power	Terminals C-34 and C-50 are internally connected in the terminal base unit.			
-V DC Common	Terminals C-35 and C-51 are internally connected in the terminal base unit.			
Chassis ground	Terminals B-16, B-33, C-38, C-40...C-45, and C-47 are internally connected to the chassis ground.			



ATTENTION: Use shielded cable for better noise immunity and easier connection to ground. Connect shield to designated ground points on the terminal base unit. Ground at the terminal base unit only.

Table 3 - Wiring Connections for the 1794-IE8X0E4 and 1794-IE8X0E4K Analog 8 Input/4 Output Module

Channel	Signal Type	Label Marking	1794-TB3G, 1794-TB3GS, 1794-TB3GK, 1794-TB3GSK	
			Output	Common Terminal
Input 0	Current	I0	A-0	B-17
	Voltage	V0	A-1	
Input 1	Current	I1	A-2	B-18
	Voltage	V1	A-3	
Input 2	Current	I2	A-4	B-23
	Voltage	V2	A-5	
Input 3	Current	I3	A-6	B-24
	Voltage	V3	A-7	
Input 4	Current	I4	A-8	B-25
	Voltage	V4	A-9	
Input 5	Current	I5	A-10	B-26
	Voltage	V5	A-11	
Input 6	Current	I6	A-12	B-31
	Voltage	V6	A-13	
Input 7	Current	I7	A-14	B-32
	Voltage	V7	A-15	
Output 0	Current	I8	B-19	C-37
	Voltage	V8	B-20	
Output 1	Current	I9	B-21	C-39
	Voltage	V9	B-22	
Output 2	Current	I10	B-27	C-46
	Voltage	V10	B-28	
Output 3	Current	I11	B-29	C-48
	Voltage	V11	B-30	
+V DC Power	Terminals C-34 and C-50 are internally connected in the terminal base unit.			
-V DC Common	Terminals C-35 and C-51 are internally connected in the terminal base unit.			
Chassis ground (shield)	Terminals B-16, B-33, C-38, C-40...C-45, and C-47 are internally connected to the chassis ground.			

Configure Your Module

You configure your input, output, or input/output module by setting bits in the configuration word.

Table 4 - Data Table – 1794-IE12 and 1794-IE12K

Dec.	15	14	13	12	11	10	9	8	7	6	5	4	3	2	1	0
Oct.	17	16	15	14	13	12	11	10	7	6	5	4	3	2	1	0
Read Words																
0 - Input 0	Signed 2's Complement data Value of Channel 0															
1 - Input 1	Signed 2's Complement data Value of Channel 1															
2 - Input 2	Signed 2's Complement data Value of Channel 2															
3 - Input 3	Signed 2's Complement data Value of Channel 3															
4 - Input 4	Signed 2's Complement data Value of Channel 4															
5 - Input 5	Signed 2's Complement data Value of Channel 5															
6 - Input 6	Signed 2's Complement data Value of Channel 6															
7 - Input 7	Signed 2's Complement data Value of Channel 7															
8 - Input 8	Signed 2's Complement data Value of Channel 8															
9 - Input 9	Signed 2's Complement data Value of Channel 9															
10 - Input 10	Signed 2's Complement data Value of Channel 10															
11 - Input 11	Signed 2's Complement data Value of Channel 11															
12 - Status	PU	FP	GF	NU	R11	R10	R9	R8	R7	R6	R5	R4	R3	R2	R1	R0
Write Words																
0 - Reserved	EN	0	0	0	0	0	0	0	0	0	0	0	0	0	0	0
1 - Configuration	QS	0	0	0	CAB		C89		C67		C45		C23		C01	

Where:

- PU = Power up bit
- FP = Field power fault
- GF = General fault
- NU = Not used
- Rx = Out of range (x = associated channel)
- EN = Enable
- QS = Quick step bit - allows input filter to be reduced during rapid signal changes.
- Cxx = Configuration

Table 5 - Range Selection Bits for the 1794-IE12, 1794-IE12K, 1794-0E12, 1794-IE8X0E4, and 1794-IE8X0E4K

Range	Out of Range	Range Setting	Cxx ⁽¹⁾ Channel Configuration
-10...+10V DC	< -10.0V or > +10.0V	Set bits for each channel pair 00 = off 01 = 0...20 mA 10 = 4...20 mA 11 = ±10V	C01 for channels 0 and 1 C23 for channels 2 and 3 C45 for channels 4 and 5 C67 for channels 6 and 7 C89 for channels 8 and 9 CAB for channels 10 and 11
4...20 mA	< 4.0 mA or > 20.0 mA		
0...20 mA	< 0.0 mA or > 20.0 mA		

(1) xx = associated channel pair

Table 6 - Safe State Selection Bits for 1794-0E12, 1794-IE8X0E4, and 1794-IE8X0E4K

When EN = 0, these bits designate the source of the safe state data for all outputs in the module

S1/S0 Safe State Select Source	Safe State Mode	Safe State Output Behavior
S1	S0	
0	0	Safe State value is in the output words Outputs will use Safe State value
0	1	Reserved (Safe State value is in the output words) Reserved (Outputs will use Safe State value)
1	0	Clear/Reset the outputs, based on range selected ±10V range - Output set to 0V 4...20 mA range - Output set to 4 mA 0...20 mA range - Output set to 0 mA
1	1	Hold output at its present level Outputs will Hold Last State

Table 7 - Data Table – 1794-0E12

Dec.	15	14	13	12	11	10	9	8	7	6	5	4	3	2	1	0
Oct.	17	16	15	14	13	12	11	10	7	6	5	4	3	2	1	0
Read Words																
0 - Status	PU	FP	GF	NU	W11	W10	W9	W8	W7	W6	W5	W4	W3	W2	W1	W0
Write Words																

Table 7 - Data Table – 1794-0E12 (Continued)

Dec.	15	14	13	12	11	10	9	8	7	6	5	4	3	2	1	0
Oct.	17	16	15	14	13	12	11	10	7	6	5	4	3	2	1	0
0 - Reserved	EN	S1	S0	WR	0	0	0	0	0	0	0	0	0	0	0	0
1 - Output 0	Signed 2's Complement data Value of Channel 0															
2 - Output 1	Signed 2's Complement data Value of Channel 1															
3 - Output 2	Signed 2's Complement data Value of Channel 2															
4 - Output 3	Signed 2's Complement data Value of Channel 3															
5 - Output 4	Signed 2's Complement data Value of Channel 4															
6 - Output 5	Signed 2's Complement data Value of Channel 5															
7 - Output 6	Signed 2's Complement data Value of Channel 6															
8 - Output 7	Signed 2's Complement data Value of Channel 7															
9 - Output 8	Signed 2's Complement data Value of Channel 8															
10 - Output 9	Signed 2's Complement data Value of Channel 9															
11 - Output 10	Signed 2's Complement data Value of Channel 10															
12 - Output 11	Signed 2's Complement data Value of Channel 11															
13 - Configuration	0	0	0	0	CAB		C89		C67		C45		C23		C01	
Where:	PU = Power-up bit FP = Field power fault GF = General fault NU = Not used Wx = Wire off (x = associated channel) EN = Enable outputs S1/S0 = Safe state source - When EN = 0, these bits indicate source of safe state output. WR = Wire-off reset Cxx = Configuration															

Table 8 - Data Table – 1794-IE8XOE4 and 1794-IE8XOE4K

Dec.	15	14	13	12	11	10	9	8	7	6	5	4	3	2	1	0
Oct.	17	16	15	14	13	12	11	10	7	6	5	4	3	2	1	0
Read Words																
0 - Input 0	Signed 2's Complement data Value of Channel 0															
1 - Input 1	Signed 2's Complement data Value of Channel 1															
2 - Input 2	Signed 2's Complement data Value of Channel 2															
3 - Input 3	Signed 2's Complement data Value of Channel 3															
4 - Input 4	Signed 2's Complement data Value of Channel 4															
5 - Input 5	Signed 2's Complement data Value of Channel 5															
6 - Input 6	Signed 2's Complement data Value of Channel 6															
7 - Input 7	Signed 2's Complement data Value of Channel 7															
8 - Status	PU	FP	GF	NU	W3	W2	W1	W0	R7	R6	R5	R4	R3	R2	R1	R0
Write Words																
0 - Reserved	EN	S1	S0	WR	0	0	0	0	0	0	0	0	0	0	0	0
1 - Output 0	Signed 2's Complement data Value of Channel 0															
2 - Output 1	Signed 2's Complement data Value of Channel 1															
3 - Output 2	Signed 2's Complement data Value of Channel 2															
4 - Output 3	Signed 2's Complement data Value of Channel 3															
5 - Configuration	QS	0	0	0	CAB		C89		C67		C45		C23		C01	
Where:	PU = Power-up bit FP = Field power fault GF = General fault NU = Not used Wx = Wire off (x = associated channel) Rx = Out of range (x = associated channel) EN = Enable outputs S1/S0 = Safe state source - When EN = 0, these bits indicate source of safe state output. WR = Wire-off reset QS = Quick step bit - allows input filter to be reduced during rapid signal changes. Cxx = Channel Configuration (xx = associated channel pair)															

Specifications

Input Specifications – 1794-IE12, 1794-IE12K, 1794-IE8X0E4, and 1794-IE8X0E4K

Attribute	1794-IE12, 1794-IE12K	1794-IE8X0E4, 1794-IE8X0E4K
Number of inputs	12 single-ended, nonisolated from channel to channel	8 single-ended, nonisolated from channel to channel
Input resolution Voltage terminal Current terminal	16 bits 320 μ V/cnt 0.641 μ A/cnt	
Data format	Left-justified, 16 bit	
Input conversion type	Successive approximation	
Input conversion rate	8.0 ms all channels	
Input voltage terminal	\pm 10V (user configurable)	
Input current terminal Specification Certification	4...20 mA (user configurable) 0...20 mA (user configurable)	
Input impedance, nom Voltage terminal Current terminal	> 1 M Ω < 100 Ω ⁽¹⁾	
Normal mode rejection ratio	Voltage/current terminal: -3 dB @ 0.05 Hz; -20 dB/decade -52 dB @ 50 Hz; -54 dB @ 60 Hz Voltage/current terminal with Quick Step: -3 dB @ 1.5 Hz; -20 dB/decade -29 dB @ 50 Hz; -31 dB @ 60 Hz	
Step response to 63% of full scale	Voltage/current terminal – 1.3 s Voltage/current terminal with Quick Step – 0.09 s	
Absolute accuracy ⁽²⁾ Voltage input Current input	0.1% full scale @ 25 °C 0.1% full scale @ 25 °C	
Accuracy drift with temperature Voltage terminal Current terminal	0.004% full Scale/°C 0.004% full Scale/°C	
Voltage overload, max	30V continuous, one channel at a time	
Current overload, max	32 mA continuous, one channel at a time	

- (1) If 24V DC is removed from the module, input resistance is < 100 Ω . This is also true at 0 mA current input even if there is 24V DC. If there is an input current applied, input impedance is > 1 M Ω .
 (2) Includes offset, gain, nonlinearity, and repeatability error terms.

Output Specifications – 1794-0E12, 1794-0E12K, 1794-IE8X0E4, and 1794-IE8X0E4K

Attribute	1794-0E12	1794-IE8X0E4, 1794-IE8X0E4K
Number of outputs	12 single-ended, nonisolated	4 single-ended, nonisolated
Output voltage terminal	0V output until module is configured \pm 10V (user configurable)	
Output current terminal	0 mA output until module is configured 4...20 mA (user configurable) 0...20 mA (user configurable)	
Output resolution Voltage terminal Current terminal	16 bit 320 μ V/cnt 0.641 μ A/cnt	
Data format	16 bit	
Output conversion type	Digital-to-analog converter	
Step response to 63% of full scale, output terminal	~70% first convert; 96% second convert; 100% third convert	
Absolute accuracy ⁽¹⁾ Voltage terminal Current terminal	0.1% full scale @ 25 °C 0.1% full scale @ 25 °C	
Accuracy drift with temperature Voltage terminal Current terminal	0.004% full scale/°C 0.004% full scale/°C	
Load on output current	0...750 Ω	
Load on voltage output, max	3.0 mA	

- (1) Includes offset, gain, nonlinearity, and repeatability error terms.

General Specifications

Attribute	1794-IE12, 1794-IE12K	1794-0E12	1794-IE8X0E4, 1794-IE8X0E4K
Recommended terminal base unit	1794-TB3G, 1794-TB3GS, 1794-TB3GK, and 1794-TB3GSK		
Terminal base screw torque	0.8 N•m (7 lb•in)		
Indicators	1 red/green power/status indicator		
Keyswitch position	3	4	5
Isolation voltage	50V (continuous), Basic Insulation Type, No isolation between individual channels Type tested @ 850V AC for 60 s between field and system		
Flexbus current	80 mA		
Power dissipation, max	1.2 W @ 31.2V DC	7.68 W @ 24V DC	3.4 W @ 24V DC
Thermal dissipation, max	4.1 BTU/hr @ 31.2V DC	26.2 BTU/hr @ 24V DC	11.6 BTU/hr @ 24V DC
Dimensions, approx. (H x W x D) (with module installed)	46 x 94 x 54 mm (1.81 x 3.7 x 2.1 in.)		
Weight, approx.	97 g (3.4 oz.)	106 g (3.7 oz.)	102 g (3.6 oz.)
Wiring category ⁽¹⁾	2 - on signal ports 2 - on power ports		
Wire type	Shielded		
Wire size	Determined by the installed terminal base		
Enclosure type rating	None (open-style)		
North American temp code	T4A		

(1) Use this Conductor Category information for planning conductor routing. See the Industrial Automation Wiring and Grounding Guidelines, publication [1770-4.1](#).

Environmental Specifications

Attribute	Value
Temperature, operating	IEC 60068-2-1 (Test Ad, Operating Cold), IEC 60068-2-2 (Test Bd, Operating Dry Heat), IEC 60068-2-14 (Test Nb, Operating Thermal Shock): -20...+60 °C (-4...+140 °F)
Temperature, nonoperating	IEC 60068-2-1 (Test Ab, Unpackaged Nonoperating Cold), IEC 60068-2-2 (Test Bb, Unpackaged Nonoperating Dry Heat), IEC 60068-2-14 (Test Na, Unpackaged Nonoperating Thermal Shock): -40...+85 °C (-40...+185 °F)
Relative humidity	IEC 60068-2-30 (Test Db, Unpackaged Nonoperating Damp Heat): 5...95% noncondensing
Vibration	IEC60068-2-6 (Test Fc, Operating): 5 g @ 10...500 Hz
Shock, operating	IEC60068-2-27 (Test Ea, Unpackaged shock): 30 g
Shock, nonoperating	IEC60068-2-27 (Test Ea, Unpackaged shock): 50 g
Emissions	IEC 61000-6-4
ESD immunity	IEC 61000-4-2: 6 kV contact discharges 8 kV air discharges
Radiated RF immunity	IEC 61000-4-3: 10V/m with 1 kHz sine-wave 80% AM from 80...2000 MHz 10V/m with 200 Hz 50% Pulse 100% AM @ 900 MHz 10V/m with 200 Hz 50% Pulse 100% AM @ 1890 MHz 10V/m with 1 kHz sine-wave 80% AM from 2000...2700 MHz - 1794-IE12, 1794-IE12K, 1794-0E12 3V/m with 1 kHz sine-wave 80% AM from 2000...2700 MHz - 1794-IE8X0E4, 1794-IE8X0E4K
EFT/B immunity	IEC 61000-4-4: ±4 kV @ 5 kHz on power ports ±4 kV @ 5 kHz on shielded signal ports - 1794-IE12, 1794-IE12K, 1794-IE8X0E4, 1794-IE8X0E4K ±2 kV @ 5 kHz on shielded signal ports - 1794-0E12
Conducted RF immunity	IEC 61000-4-6: 10V rms with 1 kHz sine-wave 80% AM from 150 kHz...80 MHz

Certifications (when product is marked)⁽¹⁾

Attribute	Value
c-UL-us	UL Listed Industrial Control Equipment, certified for US and Canada. See UL File E65584. UL Listed for Class I Division 2 Group A,B,C,D Hazardous Locations, certified for U.S. and Canada. See UL File E194810.
CE	European Union 2014/30/EU EMC Directive, compliant with: EN 61326-1; Meas./Control/Lab., Industrial Requirements EN 61000-6-2; Industrial Immunity EN 61000-6-4; Industrial Emissions EN 61131-2; Programmable Controllers (Clause 8, Zone A & B) European Union 2011/65/EU RoHS, compliant with: EN IEC 63000; Technical Documentation
RCM	Australian Radiocommunications Act compliant with: EN 61000-6-4; Industrial Emissions
KC	Korean Registration of Broadcasting and Communications Equipment, compliant with: Article 58-2 of Radio Waves Act, Clause 3
Morocco	Arrêté ministériel n° 6404-15 du 29 ramadan 1436

(1) See the Product Certification link at rok.auto/certifications for Declaration of Conformity, Certificates, and other certification details

Additional Resources

For more information on the products that are described in this publication, use these resources. You can view or download publications at rok.auto/literature.

Resource	Description
FLEX I/O and FLEX I/O-XT Selection Guide, publication 1794-SG002	Provides information on how to select FLEX I/O and FLEX I/O-XT™ adapters, terminal bases, I/O modules, and accessories.
FLEX I/O High-Density Analog Modules User Manual, publication 1794-UM062	A detailed description of module functionality, configuration, and information on how to use FLEX I/O DC input, output, and input/output analog modules.
Industrial Automation Wiring and Grounding Guidelines, publication 1770-4.1	More information on proper wiring and grounding techniques.
Product Certifications website, rok.auto/certifications	Provides declarations of conformity, certificates, and other certification details.

Notes:

Rockwell Automation Support

Use these resources to access support information.

Technical Support Center	Find help with how-to videos, FAQs, chat, user forums, Knowledgebase, and product notification updates.	rok.auto/support
Local Technical Support Phone Numbers	Locate the telephone number for your country.	rok.auto/phonesupport
Technical Documentation Center	Quickly access and download technical specifications, installation instructions, and user manuals.	rok.auto/techdocs
Literature Library	Find installation instructions, manuals, brochures, and technical data publications.	rok.auto/literature
Product Compatibility and Download Center (PCDC)	Download firmware, associated files (such as AOP, EDS, and DTM), and access product release notes.	rok.auto/pcdc

Documentation Feedback

Your comments help us serve your documentation needs better. If you have any suggestions on how to improve our content, complete the form at rok.auto/docfeedback.





Waste Electrical and Electronic Equipment (WEEE)



At the end of life, this equipment should be collected separately from any unsorted municipal waste.

Rockwell Automation maintains current product environmental compliance information on its website at rok.auto/pec.

Rockwell Otomasyon Ticaret A.Ş. Kar Plaza İş Merkezi E Blok Kat:6 34752 İçerenköy, İstanbul, Tel: +90 (216) 5698400 EEE Yönetmeliğine Uygundur

Connect with us.    

rockwellautomation.com — expanding **human possibility**[®]

AMERICAS: Rockwell Automation, 1201 South Second Street, Milwaukee, WI 53204-2496 USA, Tel: (1) 414.382.2000

EUROPE/MIDDLE EAST/AFRICA: Rockwell Automation NV, Pegasus Park, De Kleetlaan 12a, 1831 Diegem, Belgium, Tel: (32) 2663 0600

ASIA PACIFIC: Rockwell Automation SEA Pte Ltd, 2 Corporation Road, #04-05, Main Lobby, Corporation Place, Singapore 618494, Tel: (65) 6510 6608

UNITED KINGDOM: Rockwell Automation Ltd., Pitfield, Kiln Farm, Milton Keynes, MK11 3DR, United Kingdom, Tel: (44)(1908) 838-800

Allen-Bradley, expanding human possibility, FactoryTalk, FLEX, FLEX I/O-XT, Rockwell Automation, and TechConnect are trademarks of Rockwell Automation, Inc. Trademarks not belonging to Rockwell Automation are property of their respective companies.