



PowerFlex Dynamic Braking Resistor Calculator

Catalog Numbers 20A, 20B, 20F, 20G, 22A, 22B



Allen-Bradley

by ROCKWELL AUTOMATION

Application Technique

Original Instructions

Important User Information

Read this document and the documents listed in the additional resources section about installation, configuration, and operation of this equipment before you install, configure, operate, or maintain this product. Users are required to familiarize themselves with installation and wiring instructions in addition to requirements of all applicable codes, laws, and standards.

Activities including installation, adjustments, putting into service, use, assembly, disassembly, and maintenance are required to be carried out by suitably trained personnel in accordance with applicable code of practice.

If this equipment is used in a manner not specified by the manufacturer, the protection provided by the equipment may be impaired.

In no event will Rockwell Automation, Inc. be responsible or liable for indirect or consequential damages resulting from the use or application of this equipment.

The examples and diagrams in this manual are included solely for illustrative purposes. Because of the many variables and requirements associated with any particular installation, Rockwell Automation, Inc. cannot assume responsibility or liability for actual use based on the examples and diagrams.

No patent liability is assumed by Rockwell Automation, Inc. with respect to use of information, circuits, equipment, or software described in this manual.

Reproduction of the contents of this manual, in whole or in part, without written permission of Rockwell Automation, Inc., is prohibited.

Throughout this manual, when necessary, we use notes to make you aware of safety considerations.



WARNING: Identifies information about practices or circumstances that can cause an explosion in a hazardous environment, which may lead to personal injury or death, property damage, or economic loss.



ATTENTION: Identifies information about practices or circumstances that can lead to personal injury or death, property damage, or economic loss. Attentions help you identify a hazard, avoid a hazard, and recognize the consequence.

IMPORTANT Identifies information that is critical for successful application and understanding of the product.

These labels may also be on or inside the equipment to provide specific precautions.



SHOCK HAZARD: Labels may be on or inside the equipment, for example, a drive or motor, to alert people that dangerous voltage may be present.



BURN HAZARD: Labels may be on or inside the equipment, for example, a drive or motor, to alert people that surfaces may reach dangerous temperatures.



ARC FLASH HAZARD: Labels may be on or inside the equipment, for example, a motor control center, to alert people to potential Arc Flash. Arc Flash will cause severe injury or death. Wear proper Personal Protective Equipment (PPE). Follow ALL Regulatory requirements for safe work practices and for Personal Protective Equipment (PPE).

The following icon may appear in the text of this document.



Identifies information that is useful and can help to make a process easier to do or easier to understand.

Read the General Precautions	Waste Electrical and Electronic Equipment 5
	Product Safety 5
	Personal Safety 5
	Additional Resources 5
	Summary of Changes 6
	Chapter 1
Understanding How Dynamic Braking Works	How Dynamic Braking Works 7
	Dynamic Brake Components 8
	Chapter 2
Determining Dynamic Brake Requirements	How to Determine Dynamic Brake Requirements 11
	Determine Values of Equation Variables 14
	Example Calculation 19
	Chapter 3
Evaluating the PowerFlex 7-Class Internal Resistor	Evaluating the Capability of the Internal Dynamic Brake Resistor 23
	PowerFlex 70 Power Curves 26
	PowerFlex 700 Power Curves 30
	How to Evaluate a PowerFlex 750-Series Internal Resistor 32
	Chapter 4
Selecting An External Resistor for PowerFlex 7-Class Drives	How to Select an External Dynamic Brake Resistor for PowerFlex 7-Class Drives 33
	Appendix A
Minimum Dynamic Brake Resistance	PowerFlex Compact-class Drives 67
	PowerFlex Architecture-class Drives 70

Notes:

Read the General Precautions

Waste Electrical and Electronic Equipment



At the end of its life, this equipment should be collected separately from any unsorted municipal waste.

Product Safety



ATTENTION: This drive contains ESD (Electrostatic Discharge) sensitive parts and assemblies. Static control precautions are required when you install, test, service, or repair this assembly. Component damage can result if ESD control procedures are not followed. If you are not familiar with static control procedures, reference any applicable ESD protection handbook.

Personal Safety



ATTENTION: To avoid an electric shock hazard, verify that the voltage on the bus capacitors has discharged completely before servicing.

ATTENTION: Measure the DC bus voltage at the power terminal block by measuring between the +DC and -DC terminals or between the +DC and -DC test point sockets if equipped. Also measure between the +DC terminal or test point and the chassis, and between the -DC terminal or test point and the chassis. The voltage must be zero for all three measurements.

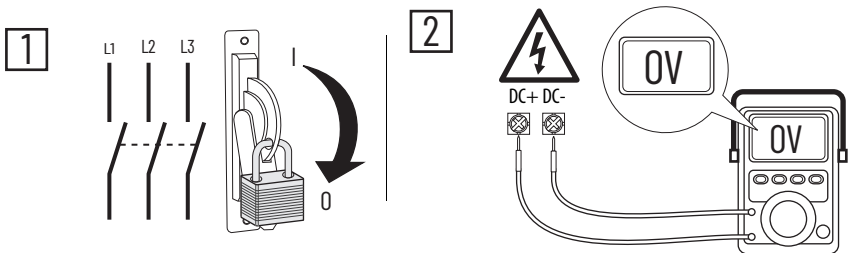

Additional Resources

You can view or download publications at <http://www.rockwellautomation.com/global/literature-library/overview.page>. To place an order for paper copies of technical documentation, contact your local Allen-Bradley distributor or Rockwell Automation® sales representative.

Summary of Changes

This manual contains new and updated information as indicated in the following table.

Topic	Page
Added 200...240V AC definitions to Appendix A	67

Understanding How Dynamic Braking Works

How Dynamic Braking Works

When an induction motor's rotor turns slower than the synchronous speed set by the drive's output power, the motor is transforming electrical energy obtained from the drive into mechanical energy available at the drive shaft of the motor. This process is referred to as *motoring*. When the rotor is turning faster than the synchronous speed set by the drive's output power, the motor is transforming mechanical energy available at the drive shaft of the motor into electrical energy that can be transferred back to the drive. This process is referred to as *regeneration*.

Most AC PWM drives convert AC power from the fixed frequency utility grid into DC power by means of a diode rectifier bridge or controlled SCR bridge before it is inverted into variable frequency AC power. Diode and SCR bridges are cost-effective, but can only handle power in the motoring direction. Therefore, if the motor is regenerating, the bridge cannot conduct the necessary negative DC current, the DC bus voltage increases and causes an overvoltage fault at the drive. More complex bridge configurations use SCRs or transistors that can transform DC regenerative electrical power into fixed frequency utility electrical energy. This process is known as *line regeneration*.

A more cost-effective solution can be provided by allowing the drive to feed the regenerated electrical power to a resistor which transforms it into thermal energy. This process is referred to as *dynamic braking*.

Dynamic Brake Components

A Dynamic Brake consists of a Chopper (the chopper transistor and related control components are built into PowerFlex® drives) and a Dynamic Brake Resistor.

Figure 1 shows a simplified Dynamic Braking schematic.

Figure 1 - Simplified Dynamic Brake Schematic

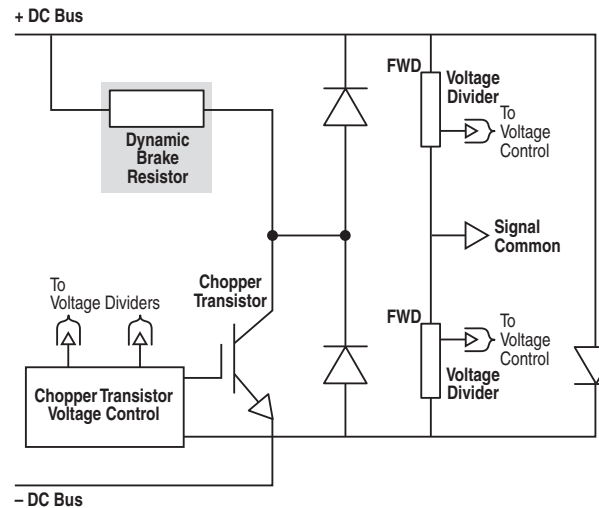

Chopper

The **Chopper** is the Dynamic Braking circuitry that senses rising DC bus voltage and shunts the excess energy to the Dynamic Brake Resistor. A Chopper contains three significant power components:

The **Chopper Transistor** is an Isolated Gate Bipolar Transistor (IGBT). The Chopper Transistor is either ON or OFF, connecting the Dynamic Brake Resistor to the DC bus and dissipating power, or isolating the resistor from the DC bus. The most important rating is the collector current rating of the Chopper Transistor that helps to determine the minimum resistance value used for the Dynamic Brake Resistor.

Chopper Transistor Voltage Control regulates the voltage of the DC bus during regeneration. The average values of DC bus voltages are:

Drive Input Voltage	Transistor Turn-On Voltage	Maximum Power Calculation Voltage
208	375V DC	395V DC
240	375V DC	395V DC
400	750V DC	790V DC
480	750V DC	790V DC
575	937.5V DC	987V DC
600	937.5V DC	987V DC
600 (Frame 5 and 6)	1076V DC	1135V DC
690	1076V DC	1135V DC

Voltage dividers reduce the DC bus voltage to a value that is usable in signal circuit isolation and control. The DC bus feedback voltage from the voltage dividers is compared to a reference voltage to actuate the Chopper Transistor.

The **Freewheel Diode** (FWD), in parallel with the Dynamic Brake Resistor, allows any magnetic energy stored in the parasitic inductance of that circuit to be safely dissipated during turn off of the Chopper Transistor.

Resistor

The **Resistor** dissipates the regenerated energy in the form of heat. The PowerFlex Family of Drives can use either the internal dynamic brake resistor option or an externally mounted dynamic brake resistor wired to the drive.

Wiring

Frames 0...4

Wire to the DB resistor should be no longer than 10 feet from the drive terminals. Wire should be twisted to minimize inductance.

Frames 5...6

Wire to the DB resistor should be no longer than 100 feet from the drive terminals.

Notes:

Determining Dynamic Brake Requirements

How to Determine Dynamic Brake Requirements

When a drive is consistently operating in the regenerative mode of operation, serious consideration should be given to equipment that transforms the electrical energy back to the fixed frequency utility grid.

As a rule, Dynamic Braking can be used when the need to dissipate regenerative energy is on an occasional or periodic basis. In general, the motor power rating, speed, torque, and details regarding the regenerative mode of operation are needed to estimate what Dynamic Brake Resistor value is needed.

The **Peak Regenerative Power** and **Average Regenerative Power** that is required for the application must be calculated to determine the resistor that is needed for the application. Once these values are determined, the resistors can be chosen. If an internal resistor is chosen, the resistor must be capable of handling the regenerated power or the drive will trip. If an external resistor is chosen, in addition to the power capabilities, the resistance must also be less than the application maximum and greater than the drive minimum or the drive will trip.

The power rating of the Dynamic Brake Resistor is estimated by applying what is known about the drive's motoring and regenerating modes of operation. The **Average Power Dissipation** must be estimated and the power rating of the Dynamic Brake Resistor that is chosen to be greater than that average. If the Dynamic Brake Resistor has a large thermodynamic heat capacity, then the resistor element will be able to absorb a large amount of energy without the temperature of the resistor element exceeding the operational temperature rating. Thermal time constants in the order of 50 seconds and higher satisfy the criteria of large heat capacities for these applications. If a resistor has a small heat capacity (defined as thermal time constants less than 5 seconds) the temperature of the resistor element could exceed its maximum.

Peak Regenerative Power can be calculated as:

- Horsepower (English units)
- Watts (The International System of Units, SI)
- Per Unit System (pu) which is relative to a value

The final number must be in watts of power to estimate the resistance value of the Dynamic Brake Resistor. The following calculations are demonstrated in SI units.

Gather the Following Information

- Power rating from motor nameplate in watts, kilowatts, or horsepower

- Speed rating from motor nameplate in rpm or rps (radians per second)
- Required decel time (per [Figure 2](#), $t_3 - t_2$). This time is a process requirement and must be within the capabilities of the drive programming.
- Motor inertia and load inertia in $\text{kg}\cdot\text{m}^2$ or WK^2 in $\text{lb}\cdot\text{ft}^2$
- Gear ratio (GR) if a gear is present between the motor and load
- Motor shaft speed, torque, and power profile of the drive application

[Figure 2](#) shows typical application profiles for speed, torque and power. The examples are for cyclical application that is periodic over t_4 seconds. The following variables are defined for [Figure 2](#):

$$\omega(t) = \text{Motor shaft speed in radians per second (rps)} \quad \omega = \frac{2\pi N}{60}$$

$$N = \text{Motor shaft speed in Revolutions Per Minute (rpm)}$$

$$T(t) = \text{Motor shaft torque in Newton-meters}$$

$$1.0 \text{ lb}\cdot\text{ft} = 1.355818 \text{ N}\cdot\text{m}$$

$$P(t) = \text{Motor shaft power in watts}$$

$$1.0 \text{ Hp} = 746 \text{ watts}$$

$$\omega_b = \text{Rated angular rotational speed } \frac{\text{Rad}}{\text{s}}$$

$$\omega_0 = \text{Angular rotational speed less than } \omega_b \text{ (can equal 0)} \frac{\text{Rad}}{\text{s}}$$

$$-P_b = \text{Motor shaft peak regenerative power in watts}$$

Figure 2 - Application Speed, Torque, and Power Profiles

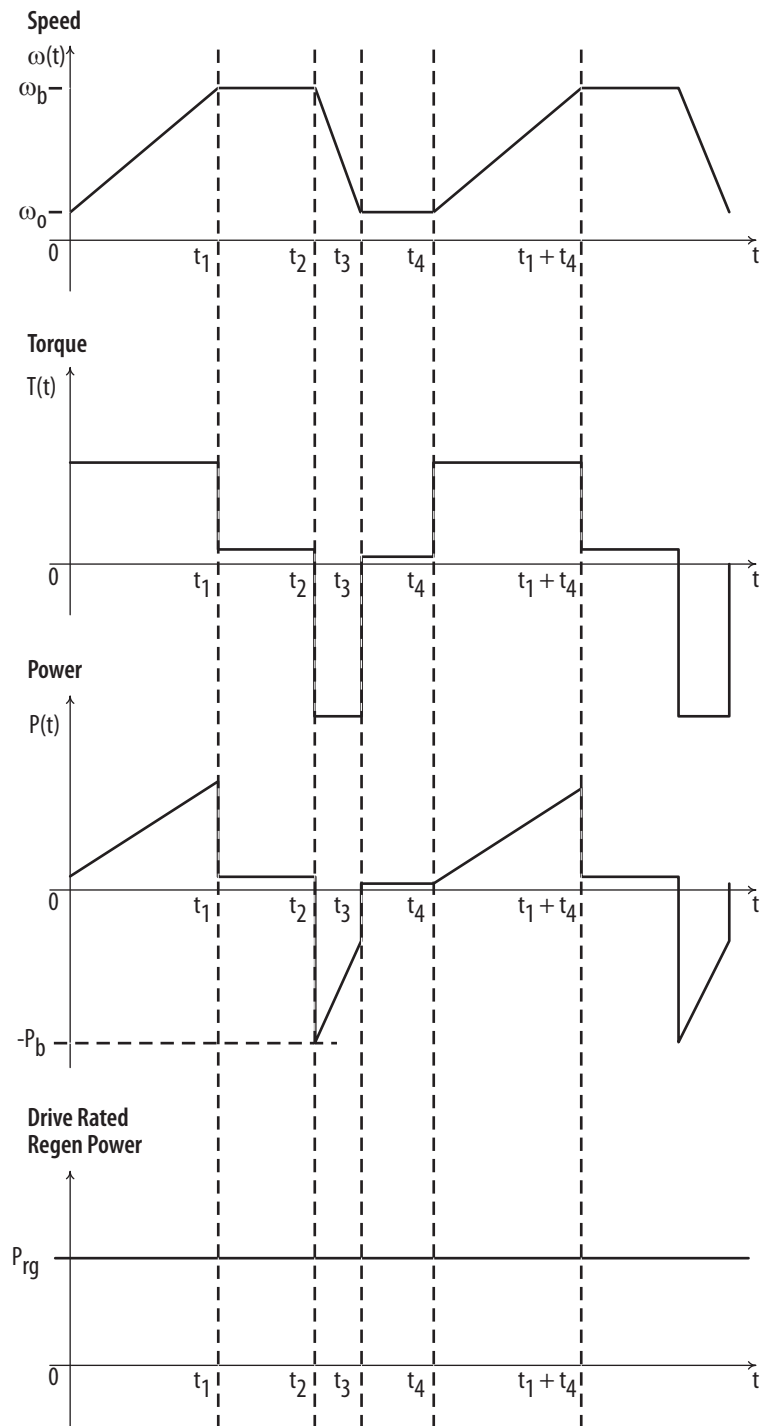

Determine Values of Equation Variables

Step 1 – Total Inertia

$$J_T = J_m + (GR^2 \times J_L)$$

J_T = Total inertia reflected to the motor shaft
(kg•m² or WK² in lb•ft²)

J_m = Motor inertia (kg•m² or WK² in lb•ft²)

GR = Gear ratio for any gear between motor and load (dimensionless)

$$GR = \frac{\text{Load Speed}}{\text{Motor Speed}}$$

If the gear ratio is 2:1 then $GR = \frac{1}{2} = 0.5$

J_L = Load inertia (kg•m² or WK² in lb•ft²)
1.0 lb•ft² = 0.04214011 kg•m²

Calculate Total Inertia:

$$J_T = [\quad] + (\quad \times \quad)$$

Record Total Inertia:

$J_T =$

Step 2 – Peak Braking Power

$$P_b = \frac{J_T[\omega_b(\omega_b - \omega_o)]}{(t_3 - t_2)}$$

P_b = Peak braking power (watts)
1.0 Hp = 746 watts

J_T = Total inertia reflected to the motor shaft (kg•m²)

ω_b = Rated angular rotational speed $\frac{Rad}{s} = \frac{2\pi N_b}{60}$

ω_o = Angular rotational speed,
less than rated speed down to zero $\frac{Rad}{s}$

N_b = Rated motor speed (rpm)

$t_3 - t_2$ = Deceleration time from ω_b to ω_o (seconds)

Calculate Peak Braking Power:

$$P_b = \frac{[\quad] \times [\quad] \times (\quad - \quad)}{(\quad - \quad)}$$

Record Peak Braking Power:

$P_b =$

Compare the peak braking power (P_b) to the drive rated regenerative power (P_{rg}). If the peak braking power is greater than the drive rated regenerative power, the decel time will have to be increased so that the drive does not enter current limit. Drive rated regenerative power (P_{rg}) is determined by:

$$P_{rg} = \frac{V^2}{R}$$

P_{rg} = Drive rated regenerative power

V = DC bus regulation voltage from [Appendix A](#)

R = Minimum brake resistance from [Appendix A](#)

$$P_{rg} = \frac{[\quad]^2}{(\quad)}$$

Record Rated Regenerative Power:

$P_{rg} =$

For the purposes of this document, it is assumed that the motor used in the application is capable of producing the required regenerative torque and power.

Step 3 – Minimum Power Requirements for the Dynamic Brake Resistors

It is assumed that the application exhibits a periodic function of acceleration and deceleration. If $(t_3 - t_2)$ equals the time in seconds necessary for deceleration from rated speed to ω_0 speed, and t_4 is the time in seconds before the process repeats itself, then the average duty cycle is $(t_3 - t_2)/t_4$. The power as a function of time is a linearly decreasing function from a value equal to the peak regenerative power to some lesser value after $(t_3 - t_2)$ seconds have elapsed. The average power regenerated over the interval of $(t_3 - t_2)$ seconds is:

$$\frac{P_b}{2} \times \frac{(\omega_b + \omega_o)}{\omega_b}$$

P_{av} = Average dynamic brake resistor dissipation (watts)

$t_3 - t_2$ = Deceleration time from ω_b to ω_0 (seconds)

t_4 = Total cycle time or period of process (seconds)

P_b = Peak braking power (watts)

ω_b = Rated angular rotational speed $\frac{Rad}{s}$

ω_0 = Angular rotational speed,
less than rated speed down to zero $\frac{Rad}{s}$

IMPORTANT If application cycle time exceeds 900 seconds, for calculation purposes t_4 will be equal to 900 plus the decel time. This is because the resistor will have cooled completely after 15 minutes.
If $t_4 > 900$ then $t_4 = 900 + (t_3 - t_2)$.

The Average Power in watts regenerated over the period t_4 is:

$$P_{av} = \left[\frac{(t_3 - t_2)}{t_4} \right] \frac{P_b}{2} \left[\frac{(\omega_b + \omega_o)}{\omega_b} \right]$$

Calculate Average Power in watts regenerated over the period t_4 :

$$P_{av} = \left[\left(\frac{\quad - \quad}{\quad} \right) \right] \times \left[\frac{\quad}{2} \right] \times \left[\left(\frac{\quad + \quad}{\quad} \right) \right]$$

Record Average Power in watts regenerated over the period t_4 :

$P_{av} =$

Step 4 – Percent Average Load of the Internal Dynamic Brake Resistor

Skip this calculation if an external dynamic brake resistor will be used.

$$AL = \frac{P_{av}}{P_{db}} \times 100$$

AL = Average load in percent of dynamic brake resistor.

IMPORTANT The value of AL should not exceed 100%.

P_{av} = Average dynamic brake resistor dissipation calculated in [Step 3 – Minimum Power Requirements for the Dynamic Brake Resistors on page 16](#) (watts)

P_{db} = Steady state power dissipation capacity of dynamic brake resistors obtained from [Appendix A](#) (watts)

Calculate Percent Average Load of the dynamic brake resistor:

$$AL = \left[\frac{\quad}{\quad} \right] \times 100$$

Record Percent Average Load of the dynamic brake resistor:

AL =

The calculation of AL is the Dynamic Brake Resistor load expressed as a percent. P_{db} is the sum of the Dynamic Brake dissipation capacity and is obtained from the

minimum dynamic brake resistance table in [Appendix A](#). This will give a data point for a line to be drawn on one the curves provided in [Chapter 3](#).

Step 5 – Percent Peak Load of the Internal Dynamic Brake Resistor

Skip this calculation if an external dynamic brake resistor will be used.

$$PL = \frac{P_b}{P_{db}} \times 100$$

PL = Peak load in percent of dynamic brake resistor

P_{av} = Peak braking power calculated in [Step 2 – Peak Braking Power on page 15](#) (watts)

P_{db} = Steady state power dissipation capacity of dynamic brake resistors obtained from [Appendix A](#) (watts)

Calculate Percent Peak Load of the dynamic brake resistor:

$$PL = \left[\frac{\quad}{\quad} \right] \times 100$$

Record Percent Average Load of the dynamic brake resistor:

PL=

The calculation of PL in percent gives the percentage of the instantaneous power dissipated by the Dynamic Brake Resistors relative to the steady state power dissipation capacity of the resistors. This will give a data point to be drawn on one of the curves provided in [Chapter 3](#).

Example Calculation

A 10 Hp, 4 Pole, 480 Volt motor and drive is accelerating and decelerating as depicted in [Figure 2](#).

- Cycle period t_4 is 40 seconds
- Rated speed is 1785 rpm and is to be decelerated to 0 speed in 15.0 seconds
- Motor load can be considered purely as inertia, and all power expended or absorbed by the motor is absorbed by the motor and load inertia
- Load inertia is $4.0 \text{ lb}\cdot\text{ft}^2$ and is directly coupled to the motor
- Motor rotor inertia is $2.2 \text{ lb}\cdot\text{ft}^2$
- A PowerFlex® 70 drive, 10 Hp 480V Normal Duty rating is chosen.

Calculate the necessary values to choose an acceptable Dynamic Brake.

$$\text{Rated Power} = 10 \text{ HP} \times 746 \text{ watts} = 7.46 \text{ kW}$$

This information was given and must be known before the calculation process begins. This can be given in Hp, but must be converted to watts before it can be used in the equations.

$$\text{Rated Speed} = \omega_b = 1785 \text{ rpm} = 2\pi \times \frac{1785}{60} = \frac{186.98 \text{ Rad}}{s}$$

$$\text{Lower Speed} = \omega_o = 0 \text{ rpm} = 2\pi \times \frac{0}{60} = \frac{0 \text{ Rad}}{s}$$

This information was given and must be known before the calculation process begins. This can be given in rpm, but must be converted to radians per second before it can be used in the equations.

$$\text{Total Inertia} = J_T = 6.2(1) \text{ lb}\cdot\text{ft}^2 = 0.0421401101 \text{ kg}\cdot\text{m}^2$$

This value can be in $\text{lb}\cdot\text{ft}^2$ or Wk^2 , but must be converted into $\text{kg}\cdot\text{m}^2$ before it can be used in the equations.

$$\text{Deceleration Time} = (t_3 - t_2) = 15 \text{ seconds}$$

$$\text{Period of Cycle} = t_4 = 40 \text{ seconds}$$

$$V_d = 790 \text{ Volts}$$

This was known because the drive is rated at 480 Volts rms. If the drive were rated 230 Volts rms, then $V_d = 395 \text{ Volts}$.

All of the preceding data and calculations were made from knowledge of the application under consideration. The total inertia was given and did not need further calculations as outlined in [Step 1 – Total Inertia](#).

$$\text{Peak Braking Power} = P_b = \frac{J_T[\omega_b(\omega_b - \omega_o)]}{(t_3 - t_2)}$$

$$P_b = \frac{0.261[186.92(186.92 - 0)]}{15} = 607.9 \text{ watts}$$

Note that this is 8.1% of rated power and is less than the maximum drive limit of 150% current limit. This calculation is the result of [Step 2 – Peak Braking Power on page 15](#) and determines the peak power that must be dissipated by the Dynamic Brake Resistor.

$$\text{Average Braking Power} = P_{av} = \left[\frac{(t_3 - t_2)}{t_4} \right] \frac{P_b}{2} \left[\frac{(\omega_b + \omega_o)}{\omega_b} \right]$$

$$P_{av} = \left(\frac{15}{40} \right) \left(\frac{607.9}{2} \right) \left(\frac{186.92 + 0}{186.92} \right) = 113.9 \text{ watts}$$

This is the result of calculating the average power dissipation as outlined in Step 4. Verify that the sum of the power ratings of the Dynamic Brake Resistors chosen in Step 3 is greater than the value calculated in Step 4.

For an internal resistor, refer to [Appendix A](#) to determine the continuous power rating of the resistor in the given drive you are using. Skip this calculation if an external dynamic brake resistor will be used.

In this case, a 10 Hp PowerFlex 70 drive has an internal resistor rated for 40 continuous watts. Because $P_{av} = 113.9$ watts, and is greater than the resistor's continuous watts rating, the drive will eventually trip on a Resistor Over Heated fault. Calculate the minimum cycle time (in seconds) using the formula in [Chapter 3, Step 2B](#).

$$\frac{\left(\frac{607.9}{2} \times 15 \right)}{40} = 113.9 \text{ seconds}$$

Recalculate the average power dissipation.

$$P_{av} = \left(\frac{15}{113.9} \right) \left(\frac{607.9}{2} \right) \left(\frac{186.92 + 0}{186.92} \right) = 40 \text{ watts}$$

If the cycle cannot be adjusted, the decel time must be extended or the system inertia lowered to reduce the average load on the resistor. Another option is to use an external resistor.

Calculate the Percent Average Load. You will need this number to calculate the Percent Peak Load.

$$\text{Percent Average Load} = AL = 100 \times \frac{P_{av}}{P_{db}}$$

$$AL = 100 \times \frac{40}{40} = 100\%$$

Important: The value of AL should not exceed 100%.

This is the result of the calculation outlined in Step 5. Record this value on [page 23](#).

$$\text{Percent Peak Load} = PL = 100 \times \frac{P_b}{P_{db}}$$

$$PL = 100 \times \frac{607.9}{40} = 1520\%$$

This is the result of the calculation outlined in Step 5. Record this value on [page 23](#).

Now that the values of AL and PL have been calculated, they can be used to determine whether an internal or external resistor can be used. Since the internal resistor package offers significant cost and space advantages, it will be evaluated first.

Notes:

Evaluating the PowerFlex 7-Class Internal Resistor

Evaluating the Capability of the Internal Dynamic Brake Resistor

To investigate the capabilities of the internal resistor package, the values of AL (Average Percent Load) and PL (Peak Percent Load) are plotted onto a graph of the Dynamic Brake Resistor's constant temperature power curve and connected with a straight line. If any portion of this line lies to the right of the constant temperature power curve, the resistor element temperature will exceed the operating temperature limit.

IMPORTANT The drive will protect the resistor and shut down the Chopper transistor. The drive will then likely trip on an over-voltage fault.

1. Record the values calculated in [Chapter 2](#).

AL=

PL=

$t_3 - t_2 =$

$P_{ave} =$

- 2A. Compare the calculated average power to the continuous rating of the dynamic brake resistor in the frame drive you have selected.

See [Appendix A](#).

Record the resistor's continuous rating.

$R_{cont} =$

- 2B. If P_{ave} is greater than R_{cont} , you will need to extend the cycle time (in seconds) by the result of the following equation.

$$\frac{\left(\frac{P_b}{2} \times Decel\right)}{R_{cont}} = seconds$$

3. Find the correct constant temperature Power Curve for your drive type, voltage and frame.

Power Curves for PowerFlex 70 Internal DB Resistors

Drive Voltage	Drive Frame(s)	Figure Number
240	A and B	3
240	C	5
240	D	6
400/480	A and B	7
400/480	C	8
400/480	D	9

OR

Power Curves for PowerFlex 700 Internal DB Resistors

Drive Voltage	Drive Frame	Figure Number
400/480	0	15
400/480	1	16
400/480	2	17
400/480	3	Uses external DB resistors only. Refer to Chapter 4

- Plot the point where the value of AL, calculated in Step 4 of [Chapter 2](#), and the desired deceleration time ($t_3 - t_2$) intersect.
- Plot the value of PL, calculated in Step 5 of [Chapter 2](#), on the vertical axis (0 seconds).
- Connect AL at ($t_3 - t_2$) and PL at 0 seconds with a straight line. This line is the power curve described by the motor as it decelerates to minimum speed.

If the line connecting AL and PL lies entirely to the left of the Power Curve, then the capability of the internal resistor is **sufficient** for the proposed application.

Figure 3 - Example of an Acceptable Resistor Power Curve

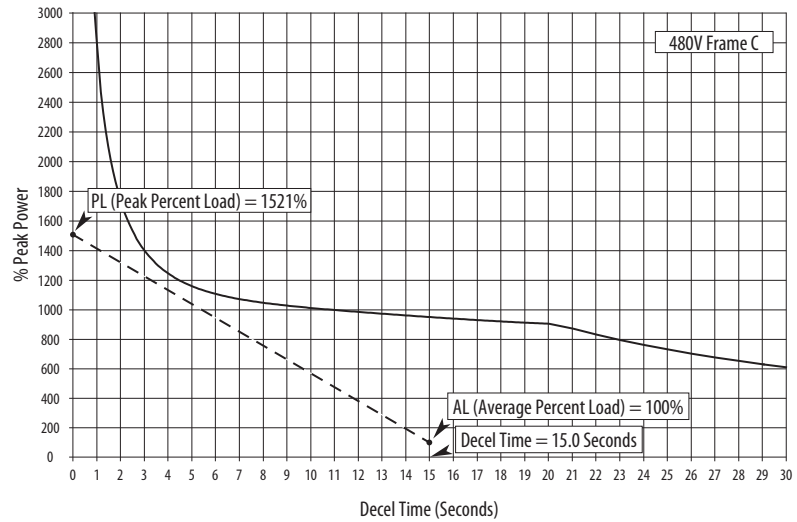

If any portion of the line connecting AL and PL lies to the right of the Power Curve, then the capability of the internal resistor is **insufficient** for the proposed application.

- Increase deceleration time ($t_3 - t_2$) until the line connecting AL and PL lies entirely to the left of the Power Curve

or

- Go to [Chapter 4](#) and select an external resistor from the tables

PowerFlex 70 Power Curves

Figure 4 - PowerFlex 70 – 240 Volt, Frames A and B

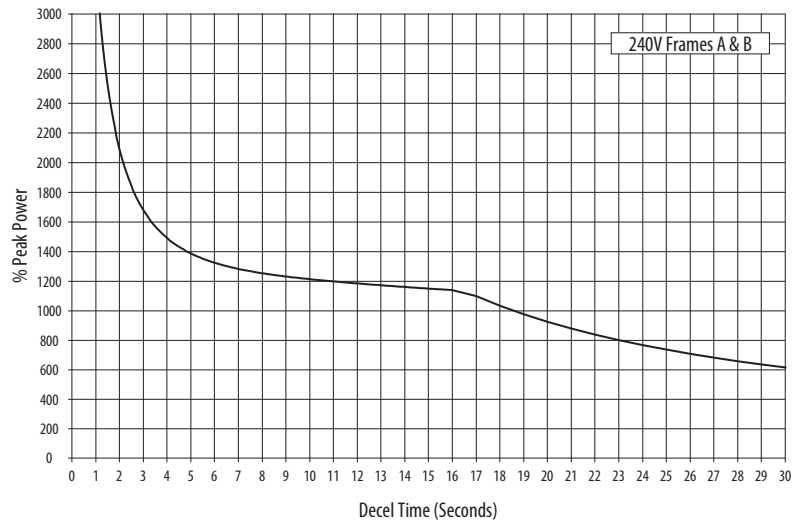

Figure 5 - PowerFlex 70 – 240 Volt, Frame C

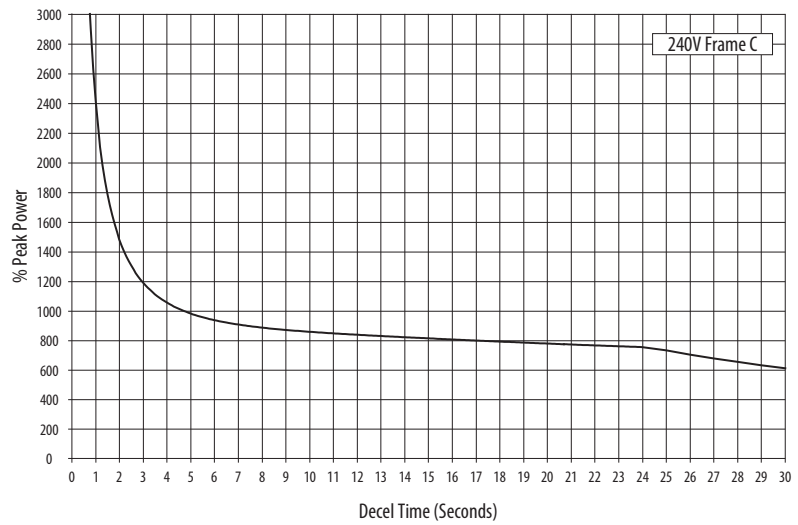

Figure 6 - PowerFlex 70 – 240 Volt, Frame D

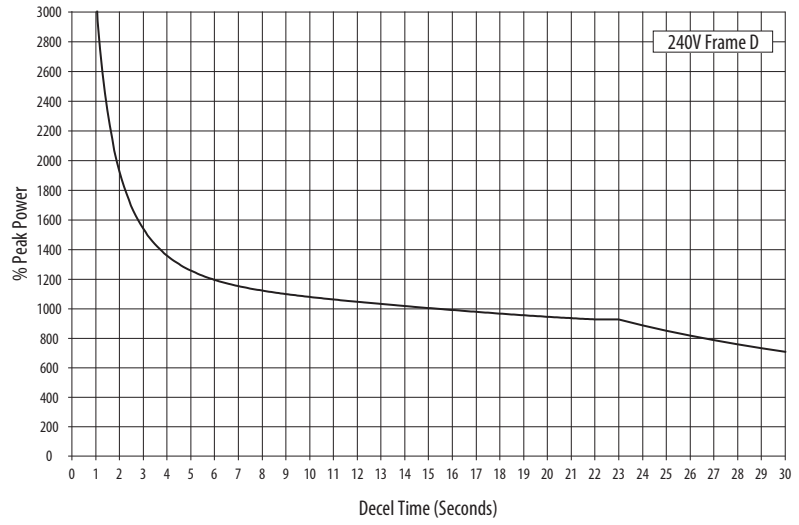

Figure 7 - PowerFlex 70 – 480 Volt, Frames A and B

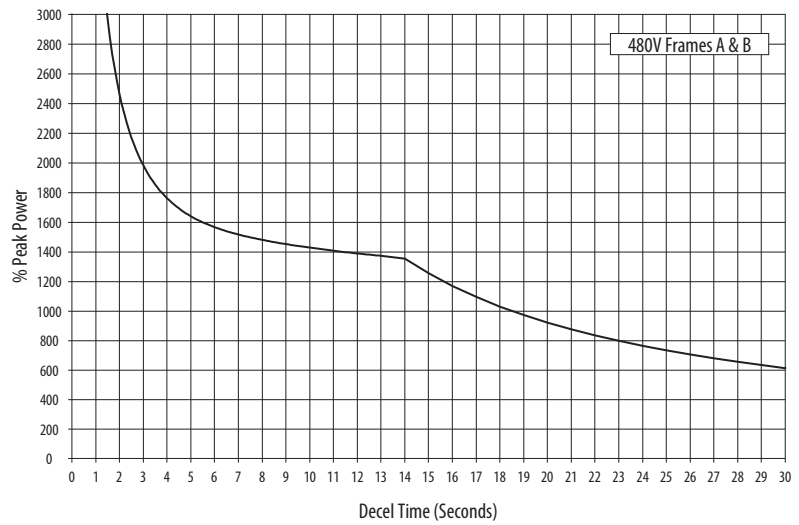

Figure 8 - PowerFlex 70 – 480 Volt, Frame C

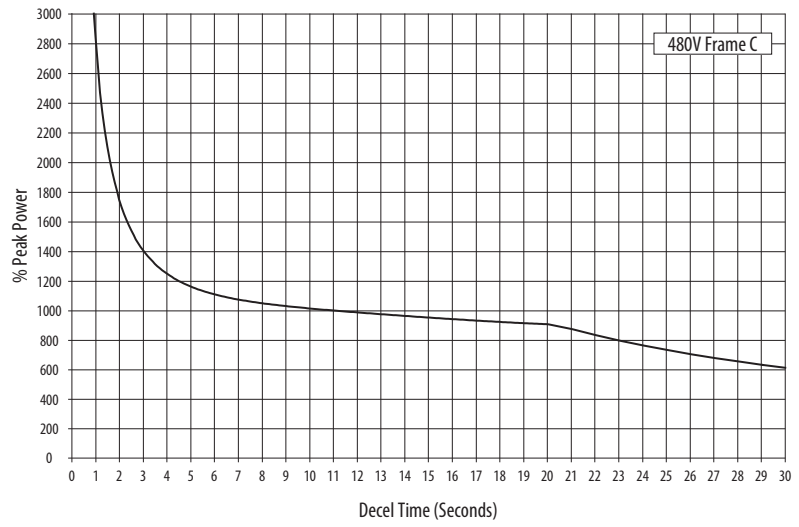

Figure 9 - PowerFlex 70 – 480 Volt, Frame D

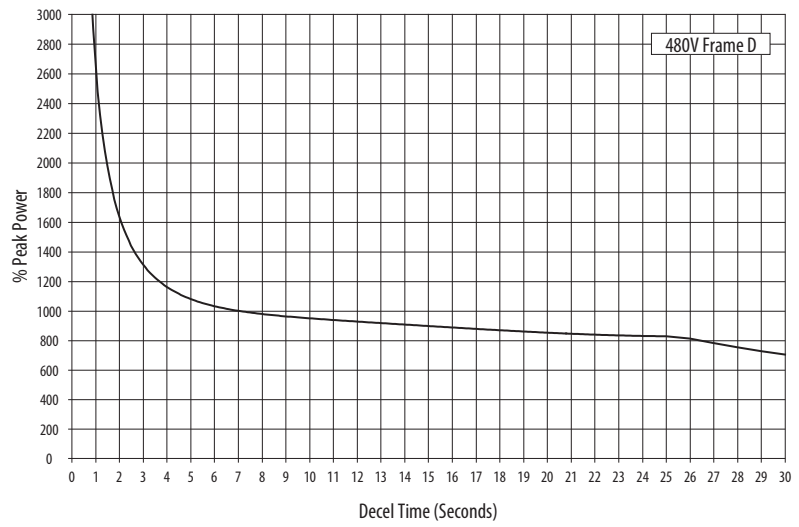

Figure 10 - PowerFlex 70 – 600 Volt, Frames A and B

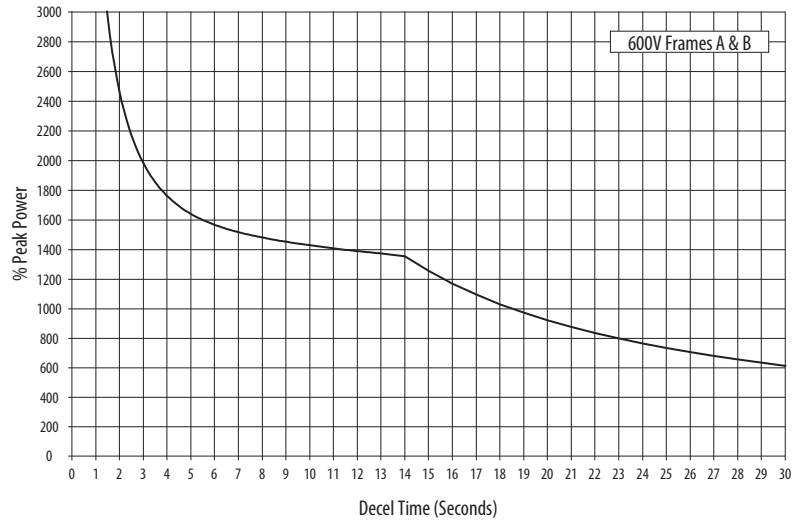
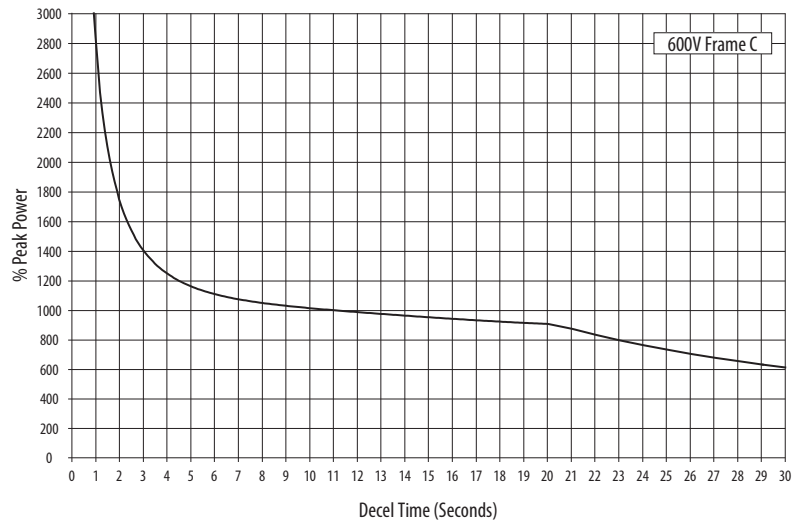

Figure 11 - PowerFlex 70 – 600 Volt, Frame C



PowerFlex 700 Power Curves

Figure 12 - PowerFlex 700 – 240 Volt, Frame 1, 2...5 Hp

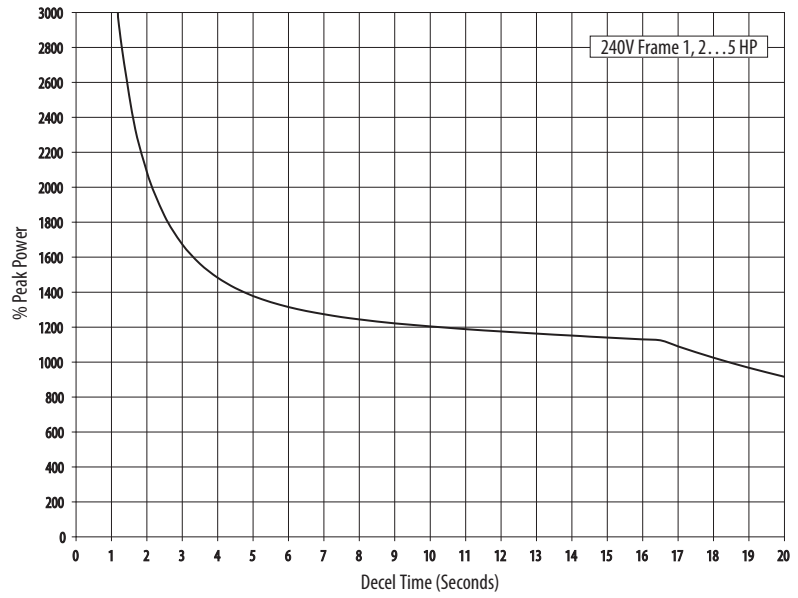

Figure 13 - PowerFlex 700 – 240 Volt, Frame 1, 7.5 Hp

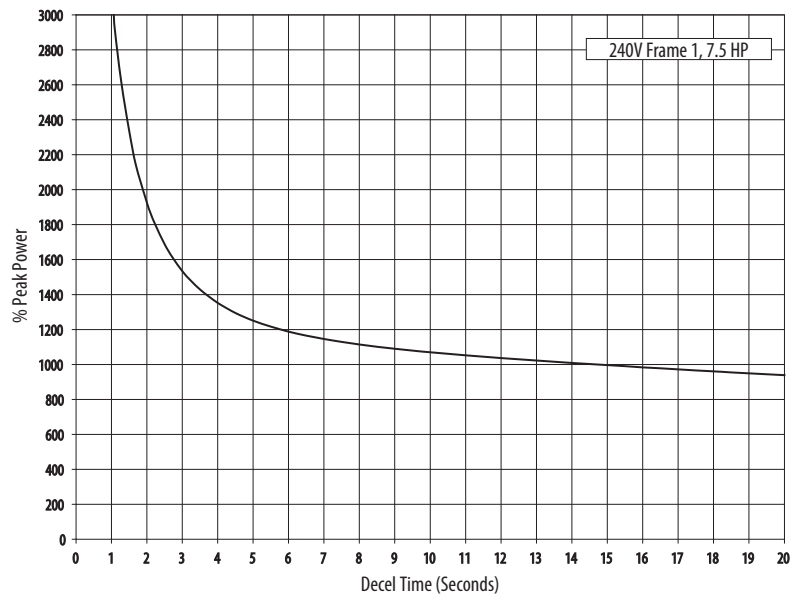

Figure 14 - PowerFlex 700 – 240 Volt, Frame 2

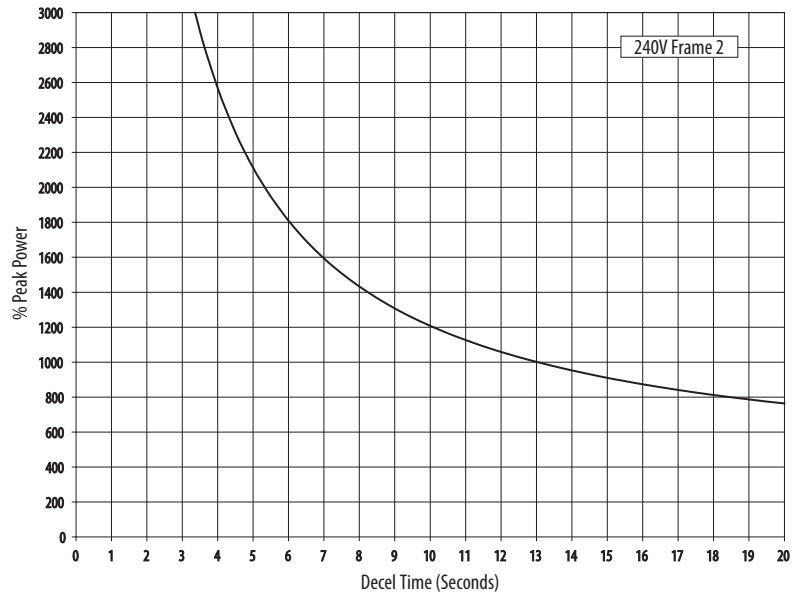

Figure 15 - PowerFlex 700 – 480 Volt, Frame 0

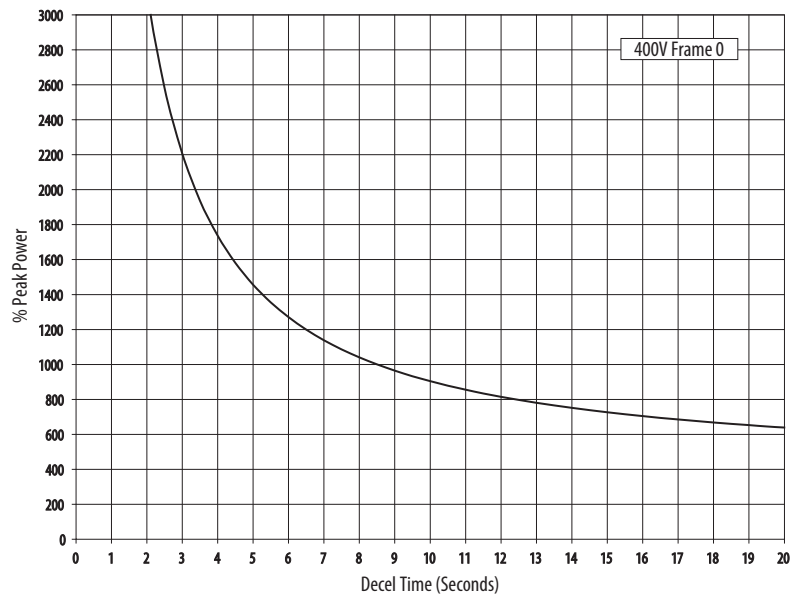

Figure 16 - PowerFlex 700 – 480 Volt, Frame 1

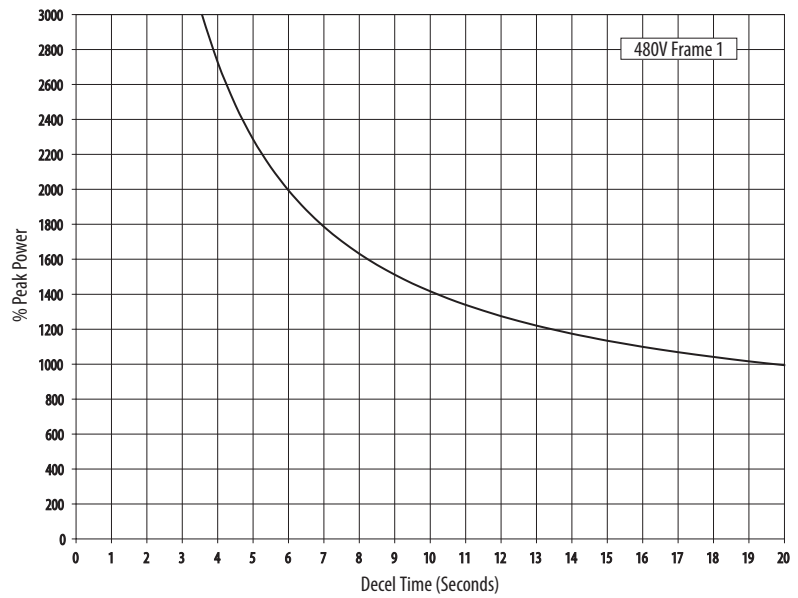
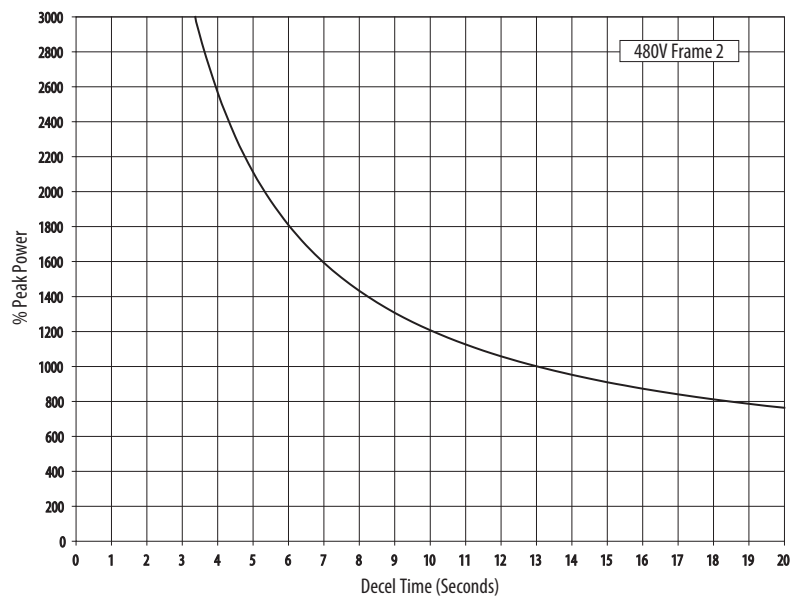

Figure 17 - PowerFlex 700 – 480 Volt, Frame 2



How to Evaluate a PowerFlex 750-Series Internal Resistor

Calculate required joule rating (joules = watt-seconds):

$$\left(\frac{P_b}{2}\right) \times (t_3 - t_2) = \text{watt-seconds}$$

Record Joule Rating (can not exceed 10,500 watt-seconds):

WS =

Selecting An External Resistor for PowerFlex 7-Class Drives

How to Select an External Dynamic Brake Resistor for PowerFlex 7-Class Drives

In order to select the appropriate External Dynamic Brake Resistor for your application, the following data must be calculated.

Peak Regenerative Power

(Expressed in watts)

This value is used to determine the maximum resistance value of the Dynamic Brake Resistor. If this value is greater than the maximum imposed by the peak regenerative power of the drive, the drive can trip off due to transient DC bus overvoltage problems.

Power Rating of the Dynamic Brake Resistor

The average power dissipation of the regenerative mode must be estimated and the power rating of the Dynamic Brake Resistor chosen to be greater than the average regenerative power dissipation of the drive.

Protecting External Resistor Packages



ATTENTION: PowerFlex drives do not offer protection for externally mounted brake resistors. A risk of fire exists if external braking resistors are not protected. External resistor packages must be self-protected from over temperature or the protective circuit show below, or equivalent, must be supplied.

Figure 18 - External Brake Resistor Circuitry

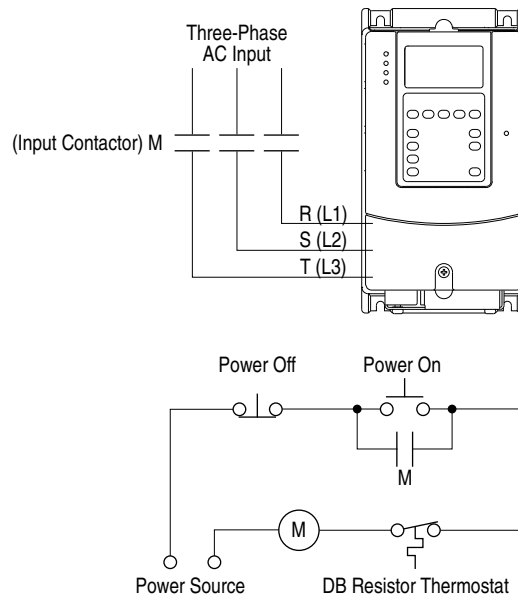

Record the Values Calculated in Section 2

$P_b =$

$P_{av} =$

Calculate Maximum Dynamic Brake Resistance Value

When using an internal Dynamic Brake Resistor, the value is fixed. However, when choosing an external resistor, the maximum allowable Dynamic Brake resistance value (R_{db1}) must be calculated.

$$R_{db1} = \frac{(V_d)^2}{P_b}$$

R_{db1} = Maximum allowable value for the dynamic brake resistor (ohms)

V_d = DC bus voltage used for calculating maximum power.
(395V DC, 790V DC, 987V DC, or 1135V DC)

P_b = Peak braking power calculated in [Step 2 – Peak Braking Power on page 15](#)
(watts)

Calculate Maximum Dynamic Brake Resistance:

$$R_{db1} = \frac{(\quad)^2}{[\quad]}$$

Record Maximum Dynamic Brake Resistance:

$R_{db1} =$

The choice of the Dynamic Brake resistance value should be less than the value calculated in this

step. If the value is greater, the drive can trip on DC bus overvoltage.

Calculate required joule rating (joules = watt-seconds):

$$\left(\frac{P_b}{2}\right) \times (t_3 - t_2) = \text{watt-seconds}$$

$$\text{watt-second losses} = \left[\frac{P_b}{2} \times (t_3 - t_2)\right] \times [1 - (\text{motor efficiency} \times \text{drive efficiency})]$$

Drive Efficiency = 0.975

$$\text{Total watt-seconds} = \text{watt-seconds} - \text{watt-second losses}$$

Select Resistor

Select a resistor bank from the following tables or from your resistor supplier that has **all** of the following:

- a resistance value that is less than the value calculated (R_{db1} in ohms)
- a resistance value that is greater than the minimum resistance listed in [Appendix A](#)
- a power value that is greater than the value calculated in [Step 3 – Minimum Power Requirements for the Dynamic Brake Resistors on page 16](#) (P_{av} in watts)
- a watt-second value greater than the value calculated.



ATTENTION: The internal dynamic brake IGBT will be damaged if the resistance value of the resistor bank is less than the minimum resistance value of the drive. Use [Appendix A](#) to verify that the resistance value of the selected resistor bank is greater than the minimum resistance of the drive.

If no resistor appears in the following tables that is greater than the minimum allowable resistance **and** is less than the calculated maximum resistance:

- Adjust the deceleration time of the application to fit an available resistor package.

or

- Use the calculated data to purchase resistors locally.

or

- Consult the factory for other possible resistor packages.

Table 1 - Resistor Selection

Ohms	Watts	Watt Seconds	Catalog	Manufacturer
956.00 Ohms				
956.00	179	4225	552-1A	PG/PG/IPC
956.00	242	4225	552-1	PG/PG/IPC
956.00	400	6260	555-1A	PG/IPC
956.00	597	6260	550-1A	PG/IPC
956.00	605	6260	555-1	PG/IPC
956.00	915	6260	550-1	PG/IPC
695.00	248	4929	552-2A	PG/IPC
695.00	333	4929	552-2	PG/IPC
695.00	553	7981	555-2A	PG/IPC
695.00	825	7981	550-2A	PG/IPC
695.00	832	7981	555-2	PG/IPC
695.00	1200	35600	PR550-2	PowerOhm
695.00	1258	15258	550-2	PG/IPC
615.00 Ohms				
615.00	180	4225	442-1A	PG/IPC
615.00	242	4225	442-1	PG/IPC

Ohms	Watts	Watt Seconds	Catalog	Manufacturer
615.00	404	4225	445-1A	PG/IPC
615.00	602	13302	440-1A	PG/IPC
615.00	605	13615	445-1	PG/IPC
615.00	800	31500	PR445-1	PowerOhm
615.00	915	13302	440-1	PG/IPC
546.00 Ohms				
546.00	316	5634	552-3A	PG/IPC
546.00	424	12050	552-3	PG/IPC
546.00	707	12050	555-3A	PG/IPC
546.00	800	28000	PR552-3	PowerOhm
546.00	1055	23004	550-3A	PG/IPC
546.00	1059	23004	555-3	PG/IPC
546.00	1200	28000	PR555-3	PowerOhm
546.00	1600	28000	PR550-3	PowerOhm
546.00	1601	36619	550-3	PG/IPC
439.00 Ohms				
439.00	254	2973	442-2A	PG/IPC
439.00	339	2973	442-2	PG/IPC
439.00	568	2973	445-2A	PG/IPC
439.00	800	22500	PR445-2	PowerOhm
439.00	847	11267	445-2	PG/IPC
439.00	848	9389	440-2A	PG/IPC
439.00	1200	22500	PR440-2	PowerOhm
439.00	1281	24647	440-2	PG/IPC
364.00 Ohms				
364.00	400	18600	PR5510-4	PowerOhm
364.00	477	3990	552-4A	PG/IPC
364.00	635	15336	552-4	PG/IPC
364.00	800	18600	PR552-4	PowerOhm
364.00	1065	24412	555-4A	PG/IPC
364.00	1200	18600	PR555-4A	PowerOhm
364.00	1588	38496	555-4	PG/IPC
364.00	1590	38496	550-4A	PG/IPC
364.00	1600	18600	PR555-4	PowerOhm
364.00	2000	29100	PR550-4	PowerOhm
364.00	2402	39514	550-4	PG/IPC
360.00 Ohms				
360.00	86	17000	AKR2360P500	Rockwell

Ohms	Watts	Watt Seconds	Catalog	Manufacturer
342.00 Ohms				
342.00	329	3677	442-3A	PG/IPC
342.00	435	3677	442-3	PG/IPC
342.00	734	14397	445-3A	PG/IPC
342.00	800	17500	PR445-3A	PowerOhm
342.00	1088	23473	445-3	PG/IPC
342.00	1096	22534	440-3A	PG/IPC
342.00	1200	17500	PR445-3	PowerOhm
342.00	1600	27400	PR440-3	PowerOhm
342.00	1645	36306	440-3	PG/IPC
283.00 Ohms				
283.00	614	19092	552-5A	PG/IPC
283.00	800	14500	PR5510-5	PowerOhm
283.00	817	19092	552-5	PG/IPC
283.00	1200	14500	PR555-5A	PowerOhm
283.00	1372	30046	555-5A	PG/IPC
283.00	2000	40900	PR555-5	PowerOhm
283.00	2043	48120	555-5	PG/IPC
283.00	2048	47338	550-5A	PG/IPC
283.00	2800	100700	PR550-5	PowerOhm
283.00	3089	76680	550-5	PG/IPC
237.00 Ohms				
237.00	400	12100	PR4405-4	PowerOhm
237.00	473	5321	442-4A	PG/IPC
237.00	628	15649	442-4	PG/IPC
237.00	800	12100	PR442-4	PowerOhm
237.00	1057	25351	445-4A	PG/IPC
237.00	1200	18900	PR445-4A	PowerOhm
237.00	1570	38496	445-4	PG/IPC
237.00	1577	39748	440-4A	PG/IPC
237.00	1600	34300	PR445-4	PowerOhm
237.00	2000	47200	PR440-4	PowerOhm
237.00	2373	61422	440-4	PG/IPC
196.00 Ohms				
196.00	400	10000	PR5505-6	PowerOhm
196.00	800	10000	PR5510-6	PowerOhm
196.00	890	20970	552-6A	PG/IPC
196.00	1180	33567	552-6	PG/IPC
196.00	1200	28300	PR552-6	PowerOhm
196.00	1600	39000	PR555-6A	PowerOhm
196.00	1987	53519	555-6A	PG/IPC
196.00	2400	69800	PR555-6	PowerOhm
196.00	2950	83096	555-6	PG/IPC
196.00	2965	83096	550-6A	PG/IPC
196.00	4000	175800	PR550-6	PowerOhm
196.00	4460	130669	550-6	PG/IPC
181.00 Ohms				
181.00	400	9200	PR4405-5	PowerOhm
181.00	620	19248	442-5A	PG/IPC
181.00	800	9200	PR4410-5	PowerOhm
181.00	822	19248	442-5	PG/IPC
181.00	1200	26100	PR445-5A	PowerOhm
181.00	1385	30985	445-5A	PG/IPC
181.00	2000	64400	PR445-5	PowerOhm
181.00	2055	77853	445-5	PG/IPC
181.00	2068	77853	440-5A	PG/IPC
181.00	2800	103100	PR440-5	PowerOhm
181.00	3108	77775	440-5	PG/IPC

Ohms	Watts	Watt Seconds	Catalog	Manufacturer
154.00 Ohms				
154.00	182	6416	222-1A	PG/IPC
154.00	242	6416	222-1	PG/IPC
154.00	400	7800	PR2205-1	PowerOhm
154.00	408	6416	225-1A	PG/IPC
154.00	604	16431	225-1	PG/IPC
154.00	610	16431	220-1A	PG/IPC
154.00	800	12300	PR225-1	PowerOhm
154.00	913	16431	220-1	PG/IPC
150.00 Ohms				
150.00	400	7700	PF150R400W	PowerOhm
150.00	800	12100	PF150R800W	PowerOhm
150.00	1200	30000	PF150R1K20	PowerOhm
150.00	1600	54200	PF150R1K60	PowerOhm
150.00	2000	53500	PF150R2K00	PowerOhm
150.00	2400	82500	PF150R2K40	PowerOhm
150.00	2800	132000	PF150R2K80	PowerOhm
150.00	3200	136500	PF150R3K20	PowerOhm
150.00	3600	196200	PF150R3K60	PowerOhm
150.00	4000	192400	PF150R4K00	PowerOhm
150.00	5200	333400	PF150R5K20	PowerOhm
150.00	5600	329100	PF150R5K60	PowerOhm
128.00 Ohms				
128.00	400	6500	PR4405-6	PowerOhm
128.00	800	18500	PR4410-6	PowerOhm
128.00	874	22065	442-6A	PG/IPC
128.00	1162	32863	442-6	PG/IPC
128.00	1200	25500	PR442-6	PowerOhm
128.00	1600	45500	PR445-6A	PowerOhm
128.00	1951	55397	445-6A	PG/IPC
128.00	2400	114800	PR445-6	PowerOhm
128.00	2906	86382	445-6	PG/IPC
128.00	2912	82626	440-6A	PG/IPC
128.00	3600	164100	PR440-6	PowerOhm
128.00	4395	138024	440-6	PG/IPC
125.00 Ohms				
125.00	400	6500	PF125R400W	PowerOhm
125.00	800	18000	PR5505-7	PowerOhm
125.00	800	18300	PF125R800W	PowerOhm
125.00	1200	24900	PR5510-7	PowerOhm
125.00	1200	25200	PF125R1K20	PowerOhm
125.00	1386	32863	552-7A	PG/IPC
125.00	1600	44200	PF125R1K60	PowerOhm
125.00	1850	51954	552-7	PG/IPC
125.00	2000	68700	PF125R2K00	PowerOhm
125.00	2800	112100	PR555-7A	PowerOhm
125.00	3095	130903	555-7A	PG/IPC
125.00	3600	161600	PF125R3K60	PowerOhm
125.00	4000	267000	PR555-7	PowerOhm
125.00	4000	277800	PF125R4K00	PowerOhm
125.00	4620	208131	550-7A	PG/IPC
125.00	4625	208131	555-7	PG/IPC
125.00	5600	282800	PR550-7	PowerOhm
125.00	6994	212513	550-7	PG/IPC
125.00	7200	341300	PF125R7K20	PowerOhm
125.00	7600	344600	PF125R7K60	PowerOhm
120.00 Ohms				
120.00	260	52000	AKR2120P1K2	Rockwell

Ohms	Watts	Watt Seconds	Catalog	Manufacturer
117.00 Ohms				
117.00	150	1200	PR117R150W	PowerOhm
117.00	250	6000	PR117R250W	PowerOhm
117.00	300	6000	PRT117R300W	PowerOhm
117.00	300	7950	T117R300W	PG/IPC
117.00	400	6000	PR117R400W	PowerOhm
117.00	600	10100	T117R600W	PG/IPC
117.00	600	17000	PRT117R600W	PowerOhm
117.00	800	17000	PR117R800W	PowerOhm
117.00	900	10600	T117R900W	PG/IPC
117.00	900	23400	PRT117R900W	PowerOhm
117.00	1200	12500	T117R1K2	PG/IPC
117.00	1200	41700	PR117R1K20	PowerOhm
117.00	1500	15800	T117R1K5	PG/IPC
117.00	1500	66700	PRT117R1K5	PowerOhm
117.00	1600	66700	PR117R1K60	PowerOhm
117.00	1800	66700	PR117R1K80	PowerOhm
117.00	2100	18600	T117R2K1	PG/IPC
117.00	2100	150000	PRT117R2K1	PowerOhm
117.00	2250	105000	PR117R2K25	PowerOhm
117.00	2700	14300	T117R2K7	PG/IPC
117.00	2700	150000	PRT117R2K7	PowerOhm
117.00	3000	20800	T117R3K0	PG/IPC
117.00	3000	250000	PRT117R3K0	PowerOhm
110.00 Ohms				
110.00	255	7511	222-2A	PG/IPC
110.00	338	7511	222-2	PG/IPC
110.00	400	5600	PR2205-2	PowerOhm
110.00	570	18779	225-2A	PG/IPC
110.00	800	15900	PR225-2	PowerOhm
110.00	845	18779	225-2	PG/IPC
110.00	850	18779	220-2A	PG/IPC
110.00	1200	39100	PR220-2	PowerOhm
110.00	1278	46947	220-2	PG/IPC
100.00 Ohms				
100.00	400	5200	PF100R400W	PowerOhm
100.00	800	20000	PF100R800W	PowerOhm
100.00	1200	35300	PF100R1K20	PowerOhm
100.00	1600	55000	PF100R1K60	PowerOhm
100.00	2000	89800	PF100R2K00	PowerOhm
100.00	2400	130800	PF100R2K40	PowerOhm
100.00	2800	125700	PF100R2K80	PowerOhm
100.00	3600	211600	PF100R3K60	PowerOhm
100.00	4000	205200	PF100R4K00	PowerOhm
100.00	4800	285500	PF100R4K80	PowerOhm
100.00	5200	275000	PF100R5K20	PowerOhm
100.00	5600	273100	PF100R5K60	PowerOhm
100.00	6800	450100	PF100R6K80	PowerOhm
100.00	8000	692400	PF100R8K00	PowerOhm
100.00	9200	676300	PF100R9K20	PowerOhm
97.00 Ohms				
97.00	150	2200	PR97R150W	PowerOhm
97.00	250	5000	PR97R250W	PowerOhm
97.00	300	5000	PRT97R300W	PowerOhm
97.00	300	10300	T97R300W	PG/IPC
97.00	400	5000	PR97R400W	PowerOhm
97.00	600	13400	T97R600W	PG/IPC
97.00	600	19400	PRT97R600W	PowerOhm
97.00	800	19400	PR97R800W	PowerOhm

Ohms	Watts	Watt Seconds	Catalog	Manufacturer
97.00	900	13800	T97R900W	PG/IPC
97.00	900	34600	PRT97R900W	PowerOhm
97.00	1200	16500	T97R1K2	PG/IPC
97.00	1200	34600	PR97R1K20	PowerOhm
97.00	1200	55300	PRT97R1K2	PowerOhm
97.00	1500	20800	T97R1K5	PG/IPC
97.00	1500	87100	PRT97R1K5	PowerOhm
97.00	1600	55300	PR97R1K60	PowerOhm
97.00	2100	15400	T97R2K1	PG/IPC
97.00	2100	124400	PRT97R2K1	PowerOhm
97.00	2250	87100	PR97R2K25	PowerOhm
97.00	2700	19100	T97R2K7	PG/IPC
97.00	2700	124400	PR97R2K70	PowerOhm
97.00	2700	207300	PRT97R2K7	PowerOhm
97.00	3000	16800	T97R3K0	PG/IPC
97.00	3000	199000	PRT97R3K0	PowerOhm
97.00	3600	22400	T97R3K6	PG/IPC
97.00	3600	207200	PR97R3K60	PowerOhm
97.00	3600	278000	PRT97R3K6	PowerOhm
97.00	4200	19100	T97R4K2	PG/IPC
97.00	4200	266500	PRT97R4K2	PowerOhm
91.00 Ohms				
91.00	86	17000	AKR2091P500	Rockwell
85.00 Ohms				
85.00	326	9076	222-3A	PG/IPC
85.00	400	6800	PR2205-3	PowerOhm
85.00	400	6900	PF85R400W	PowerOhm
85.00	438	9076	222-3	PG/IPC
85.00	730	23004	225-3A	PG/IPC
85.00	800	16900	PR225-3A	PowerOhm
85.00	800	17200	PF85R800W	PowerOhm
85.00	1089	36384	220-3A	PG/IPC
85.00	1094	36384	225-3	PG/IPC
85.00	1200	46200	PF85R1K20	PowerOhm
85.00	1200	48400	PR225-3	PowerOhm
85.00	1600	75400	PF85R1K60	PowerOhm
85.00	1600	76200	PR220-3	PowerOhm
85.00	1654	57901	220-3	PG/IPC
85.00	2000	109000	PF85R2K00	PowerOhm
85.00	2056	57588	552-8A	PG/IPC
85.00	2400	108900	PR552-8	PowerOhm
85.00	2720	92016	552-8	PG/IPC
85.00	2800	179500	PF85R2K80	PowerOhm
85.00	3600	173600	PF85R3K60	PowerOhm
85.00	3600	174300	PR555-8A	PowerOhm
85.00	4592	233795	555-8A	PG/IPC
85.00	5200	379200	PF85R5K20	PowerOhm
85.00	5600	381400	PR555-8	PowerOhm
85.00	5600	383300	PF85R5K60	PowerOhm
85.00	6800	588500	PF85R6K80	PowerOhm
85.00	6801	231135	555-8	PG/IPC
85.00	6854	231135	550-8A	PG/IPC
85.00	7200	578500	PF85R7K20	PowerOhm
85.00	8800	953500	PR550-8	PowerOhm
85.00	10000	934100	PF85R10K0	PowerOhm
85.00	10285	361490	550-8	PG/IPC
85.00	11200	923100	PF85R11K2	PowerOhm

Ohms	Watts	Watt Seconds	Catalog	Manufacturer
81.00 Ohms				
81.00	400	6400	PR4405-7A	PowerOhm
81.00	800	28800	PR4405-7	PowerOhm
81.00	1200	46100	PR4410-7	PowerOhm
81.00	1389	34975	442-7A	PG/IPC
81.00	1600	72600	PR442-7	PowerOhm
81.00	1837	55084	442-7	PG/IPC
81.00	2800	173000	PR445-7A	PowerOhm
81.00	3102	55319	445-7A	PG/IPC
81.00	3600	183200	PR445-7	PowerOhm
81.00	4000	183200	PR440-7A	PowerOhm
81.00	4592	224640	445-7	PG/IPC
81.00	4629	221432	440-7A	PG/IPC
81.00	5600	132100	PR440-7	PowerOhm
81.00	6944	221276	440-7	PG/IPC
80.00 Ohms				
80.00	250	6500	PR80R250W	PowerOhm
80.00	300	6500	PRT80R300W	PowerOhm
80.00	300	8530	T80R300W	PG/IPC
80.00	400	6500	PF80R400W	PowerOhm
80.00	600	10900	T80R600W	PG/IPC
80.00	600	16000	PRT80R600W	PowerOhm
80.00	800	16000	PF80R800W	PowerOhm
80.00	800	28500	PR80R800W	PowerOhm
80.00	900	18500	T80R900W	PG/IPC
80.00	900	45600	PRT80R900W	PowerOhm
80.00	1200	13700	T80R1K2	PG/IPC
80.00	1200	44600	PF80R1K20	PowerOhm
80.00	1200	71800	PRT80R1K2	PowerOhm
80.00	1500	17500	T80R1K5	PG/IPC
80.00	1500	102600	PRT80R1K5	PowerOhm
80.00	1600	71800	PR80R1K60	PowerOhm
80.00	1800	71800	PR80R1K80	PowerOhm
80.00	2000	102600	PF80R2K00	PowerOhm
80.00	2100	19100	T80R2K1	PG/IPC
80.00	2100	171000	PRT80R2K1	PowerOhm
80.00	2250	102600	PR80R2K25	PowerOhm
80.00	2700	24600	T80R2K7	PG/IPC
80.00	2700	102600	PR80R2K70	PowerOhm
80.00	2700	229300	PRT80R2K7	PowerOhm
80.00	3000	22100	T80R3K0	PG/IPC
80.00	3000	229300	PRT80R3K0	PowerOhm
80.00	3150	170900	PR80R3K15	PowerOhm
80.00	3600	18500	T80R3K6	PG/IPC
80.00	3600	164100	PR80R3K60	PowerOhm
80.00	3600	219800	PRT80R3K6	PowerOhm
80.00	4000	229300	PF80R4K00	PowerOhm
80.00	4050	229100	PR80R4K05	PowerOhm
80.00	4200	25100	T80R4K2	PG/IPC
80.00	4200	359000	PRT80R4K2	PowerOhm
80.00	4500	23300	T80R4K5	PG/IPC
80.00	4500	354400	PRT80R4K5	PowerOhm
80.00	4950	219700	PR80R4K95	PowerOhm
80.00	5700	29400	T80R5K7	PG/IPC
80.00	5700	897500	PRT80R5K7	PowerOhm
80.00	5850	358800	PR80R5K85	PowerOhm
80.00	7600	545700	PF80R7K60	PowerOhm
80.00	8000	897500	PF80R8K00	PowerOhm
80.00	9000	209000	T80R9K0	PG/IPC

Ohms	Watts	Watt Seconds	Catalog	Manufacturer
80.00	9000	1435900	PRT80R9K0	PowerOhm
80.00	9300	230000	T80R9K3	PG/IPC
80.00	9300	1435900	PRT80R9K3	PowerOhm
77.00 Ohms				
77.00	250	6200	PR77R250W	PowerOhm
77.00	300	6200	PRT77R300W	PowerOhm
77.00	300	8210	T77R300W	PG/IPC
77.00	400	6200	PR77R400W	PowerOhm
77.00	600	10600	T77R600W	PG/IPC
77.00	600	15400	PRT77R600W	PowerOhm
77.00	800	27500	PR77R800W	PowerOhm
77.00	900	17900	T77R900W	PG/IPC
77.00	900	43900	PRT77R900W	PowerOhm
77.00	1200	20800	T77R1K2	PG/IPC
77.00	1200	43900	PR77R1K20	PowerOhm
77.00	1200	69200	PRT77R1K2	PowerOhm
77.00	1500	16400	T77R1K5	PG/IPC
77.00	1500	98800	PRT77R1K5	PowerOhm
77.00	1600	69100	PR77R1K60	PowerOhm
77.00	1800	69100	PR77R1K80	PowerOhm
77.00	2100	19100	T77R2K1	PG/IPC
77.00	2100	164600	PRT77R2K1	PowerOhm
77.00	2250	98800	PR77R2K25	PowerOhm
77.00	2700	23800	T77R2K7	PG/IPC
77.00	2700	220700	PRT77R2K7	PowerOhm
77.00	3000	21300	T77R3K0	PG/IPC
77.00	3000	211600	PRT77R3K0	PowerOhm
77.00	3150	158000	PR77R3K15	PowerOhm
77.00	3600	28100	T77R3K6	PG/IPC
77.00	3600	157900	PR77R3K60	PowerOhm
77.00	3600	211600	PRT77R3K6	PowerOhm
77.00	4050	220600	PR77R4K05	PowerOhm
77.00	4200	24200	T77R4K2	PG/IPC
77.00	4200	341100	PRT77R4K2	PowerOhm
77.00	4500	22400	T77R4K5	PG/IPC
77.00	4500	533100	PRT77R4K5	PowerOhm
77.00	5700	28700	T77R5K7	PG/IPC
77.00	5700	863800	PRT77R5K7	PowerOhm
77.00	9000	209000	T77R9K0	PG/IPC
77.00	9000	1382100	PRT77R9K0	PowerOhm
77.00	9300	230000	T77R9K3	PG/IPC
77.00	9300	1382100	PRT77R9K3	PowerOhm
70.00 Ohms				
70.00	400	5700	PF70R400W	PowerOhm
70.00	800	24900	PR5505-9A	PowerOhm
70.00	800	25000	PF70R800W	PowerOhm
70.00	1200	39800	PR5505-9	PowerOhm
70.00	1200	62000	PF70R1K20	PowerOhm
70.00	2000	89700	PR5510-9	PowerOhm
70.00	2400	153900	PF70R2K40	PowerOhm
70.00	2527	76680	552-9A	PG/IPC
70.00	2800	143500	PR552-9	PowerOhm
70.00	3303	144048	552-9	PG/IPC
70.00	4800	114200	PR555-9A	PowerOhm
70.00	4800	308300	PF70R4K80	PowerOhm
70.00	5643	189665	555-9A	PG/IPC
70.00	7200	785200	PR555-9	PowerOhm
70.00	8258	297173	555-9	PG/IPC
70.00	8424	295765	550-9A	PG/IPC

Ohms	Watts	Watt Seconds	Catalog	Manufacturer
70.00	9600	1249300	PF70R9K60	PowerOhm
70.00	10400	251200	PR550-9	PowerOhm
70.00	12489	482144	550-9	PG/IPC
65.00 Ohms				
65.00	400	9500	PF65R400W	PowerOhm
65.00	800	23600	PF65R800W	PowerOhm
65.00	1200	59300	PF65R1K20	PowerOhm
65.00	2000	138900	PF65R2K00	PowerOhm
65.00	2400	141100	PF65R2K40	PowerOhm
65.00	3600	178100	PF65R3K60	PowerOhm
65.00	4000	291700	PF65R4K00	PowerOhm
65.00	7200	712100	PF65R7K20	PowerOhm
65.00	7600	709900	PF65R7K60	PowerOhm
65.00	16640	690800	PF65R16K6	PowerOhm
60.00 Ohms				
60.00	150	3400	PR60R150W	PowerOhm
60.00	250	8700	PR60R250W	PowerOhm
60.00	300	8700	PRT60R300W	PowerOhm
60.00	300	10300	T60R300W	PG/IPC
60.00	400	8700	PF60R400W	PowerOhm
60.00	520	104000	2-AKR2120P1K2	Rockwell
60.00	600	13000	T60R600W	PG/IPC
60.00	600	21400	PRT60R600W	PowerOhm
60.00	800	21400	PF60R800W	PowerOhm
60.00	800	34200	PR60R800W	PowerOhm
60.00	900	13700	T60R900W	PG/IPC
60.00	900	53900	PRT60R900W	PowerOhm
60.00	1200	16400	T60R1K2	PG/IPC
60.00	1200	53900	PR60R1K20	PowerOhm
60.00	1200	77000	PRT60R1K2	PowerOhm
60.00	1500	20800	T60R1K5	PG/IPC
60.00	1500	128300	PRT60R1K5	PowerOhm
60.00	2000	128300	PF60R2K00	PowerOhm
60.00	2250	128300	PR60R2K25	PowerOhm
60.00	2700	18500	T60R2K7	PG/IPC
60.00	2700	123100	PR60R2K70	PowerOhm
60.00	2700	164900	PRT60R2K7	PowerOhm
60.00	3600	22000	T60R3K6	PG/IPC
60.00	3600	164900	PR60R3K60	PowerOhm
60.00	3600	415400	PRT60R3K6	PowerOhm
60.00	4000	269300	PF60R4K00	PowerOhm
60.00	4500	28000	T60R4K5	PG/IPC
60.00	4500	269300	PR60R4K50	PowerOhm
60.00	4500	673100	PRT60R4K5	PowerOhm
60.00	4950	265600	PR60R4K95	PowerOhm
60.00	5850	409800	PR60R5K85	PowerOhm
60.00	6900	164000	T60R6K9	PG/IPC
60.00	6900	1077000	PRT60R6K9	PowerOhm
60.00	7650	657600	PR60R7K65	PowerOhm
60.00	8000	659400	PF60R8K00	PowerOhm
60.00	11000	448000	T60R11K0	PG/IPC
60.00	11000	2051300	PRT60R11K0	PowerOhm
60.00	15896	690800	PF60R15K8	PowerOhm
59.00 Ohms				
59.00	400	8500	PR2205-4	PowerOhm
59.00	473	10094	222-4A	PG/IPC
59.00	631	25038	222-4	PG/IPC
59.00	800	33600	PR222-4	PowerOhm
59.00	1056	39201	225-4A	PG/IPC

Ohms	Watts	Watt Seconds	Catalog	Manufacturer
59.00	1200	52900	PR225-4A	PowerOhm
59.00	1576	64161	225-4	PG/IPC
59.00	1577	64161	220-4A	PG/IPC
59.00	1600	75600	PR225-4	PowerOhm
59.00	2000	126000	PR220-4	PowerOhm
59.00	2384	99762	220-4	PG/IPC
56.00 Ohms				
56.00	800	31900	PR4405-8	PowerOhm
56.00	1200	50200	PR4410-8A	PowerOhm
56.00	1600	71700	PR4410-8	PowerOhm
56.00	2010	61344	442-8A	PG/IPC
56.00	2400	114800	PR442-8	PowerOhm
56.00	2657	154455	442-8	PG/IPC
56.00	3600	251200	PR445-8A	PowerOhm
56.00	4490	245062	445-8A	PG/IPC
56.00	5600	628200	PR445-8	PowerOhm
56.00	6642	245375	445-8	PG/IPC
56.00	6702	245375	440-8A	PG/IPC
56.00	8000	201000	PR440-8	PowerOhm
56.00	10045	388094	440-8	PG/IPC
55.00 Ohms				
55.00	400	8000	PF55R400W	PowerOhm
55.00	800	30800	PF55R800W	PowerOhm
52.00 Ohms				
52.00	400	10400	PF52R400W	PowerOhm
52.00	800	28600	PF52R800W	PowerOhm
52.00	1200	65400	PF52R1K20	PowerOhm
52.00	1600	111200	PF52R1K60	PowerOhm
52.00	2400	149600	PF52R2K40	PowerOhm
52.00	2800	142400	PF52R2K80	PowerOhm
52.00	3200	233400	PF52R3K20	PowerOhm
52.00	4800	352900	PF52R4K80	PowerOhm
52.00	5600	569300	PF52R5K60	PowerOhm
52.00	6000	577000	PF52R6K00	PowerOhm
52.00	9600	598400	PF52R9K60	PowerOhm
52.00	13312	621800	PF52R13K3	PowerOhm
52.00	18625	583500	PF52R18K6	PowerOhm
48.00 Ohms				
48.00	150	2700	PR48R150W	PowerOhm
48.00	250	9600	PR48R250W	PowerOhm
48.00	300	9600	PRT48R300W	PowerOhm
48.00	300	13100	T48R300W	PG/IPC
48.00	400	9600	PF48R400W	PowerOhm
48.00	600	16500	T48R600W	PG/IPC
48.00	600	27400	PRT48R600W	PowerOhm
48.00	800	26400	PF48R800W	PowerOhm
48.00	800	27400	PR48R800W	PowerOhm
48.00	900	17500	T48R900W	PG/IPC
48.00	900	61600	PRT48R900W	PowerOhm
48.00	1200	20800	T48R1K2	PG/IPC
48.00	1200	61600	PF48R1K20	PowerOhm
48.00	1200	102600	PRT48R1K2	PowerOhm
48.00	1500	16600	T48R1K5	PG/IPC
48.00	1500	98500	PRT48R1K5	PowerOhm
48.00	1600	102600	PR48R1K60	PowerOhm
48.00	2000	98500	PF48R2K00	PowerOhm
48.00	2700	23300	T48R2K7	PG/IPC
48.00	2700	137600	PR48R2K70	PowerOhm
48.00	2700	212600	PRT48R2K7	PowerOhm

Ohms	Watts	Watt Seconds	Catalog	Manufacturer
48.00	3000	21100	T48R3K0	PG/IPC
48.00	3000	332400	PRT48R3K0	PowerOhm
48.00	3150	131800	PR48R3K15	PowerOhm
48.00	3600	28000	T48R3K6	PG/IPC
48.00	3600	86200	PF48R3K60	PowerOhm
48.00	3600	538500	PRT48R3K6	PowerOhm
48.00	4200	23800	T48R4K2	PG/IPC
48.00	4200	527500	PRT48R4K2	PowerOhm
48.00	4950	328000	PR48R4K95	PowerOhm
48.00	5670	131000	T48R5K67	PG/IPC
48.00	5670	861600	PRT48R5K67	PowerOhm
48.00	5850	527200	PR48R5K85	PowerOhm
48.00	6600	131000	T48R6K6	PG/IPC
48.00	6600	861600	PRT48R6K6	PowerOhm
48.00	7650	860500	PR48R7K65	PowerOhm
48.00	9450	859400	PR48R9K45	PowerOhm
48.00	12600	359000	T48R12K6	PG/IPC
48.00	12600	460500	PRT48R12K6	PowerOhm
48.00	19100	656000	T48R19K1	PG/IPC
48.00	19100	817300	PRT48R19K1	PowerOhm
48.00	20400	716000	T48R20K4	PG/IPC
48.00	20400	817300	PRT48R20K4	PowerOhm
47.00 Ohms				
47.00	166	33000	AKR2047P500	Rockwell
45.00 Ohms				
45.00	300	9000	PRT45R300W	PowerOhm
45.00	300	12300	T45R300W	PG/IPC
45.00	400	8900	PR2205-5	PowerOhm
45.00	400	9000	PR45R400W	PowerOhm
45.00	600	15800	T45R600W	PG/IPC
45.00	600	25700	PRT45R600W	PowerOhm
45.00	617	30828	222-5A	PG/IPC
45.00	800	40300	PR2210-5	PowerOhm
45.00	827	30828	222-5	PG/IPC
45.00	1200	19100	T45R1K2	PG/IPC
45.00	1200	57600	PR225-5A	PowerOhm
45.00	1200	57700	PR45R1K20	PowerOhm
45.00	1200	96200	PRT45R1K2	PowerOhm
45.00	1378	49529	225-5A	PG/IPC
45.00	1500	24900	T45R1K5	PG/IPC
45.00	1500	92400	PRT45R1K5	PowerOhm
45.00	1600	96100	PR5505-10	PowerOhm
45.00	2000	101800	PR225-5	PowerOhm
45.00	2056	124800	220-5A	PG/IPC
45.00	2066	124800	225-5	PG/IPC
45.00	2100	28100	T45R2K1	PG/IPC
45.00	2100	123700	PRT45R2K1	PowerOhm
45.00	2250	92400	PR45R2K25	PowerOhm
45.00	2700	22000	T45R2K7	PG/IPC
45.00	2700	311600	PRT45R2K7	PowerOhm
45.00	2800	201900	PR220-5	PowerOhm
45.00	3000	19800	T45R3K0	PG/IPC
45.00	3000	307700	PRT45R3K0	PowerOhm
45.00	3125	197177	220-5	PG/IPC
45.00	3200	73400	PR552-10A	PowerOhm
45.00	3600	26600	T45R3K6	PG/IPC
45.00	3600	199200	PR45R3K60	PowerOhm
45.00	3600	494600	PRT45R3K6	PowerOhm
45.00	3883	120810	552-10A	PG/IPC

Ohms	Watts	Watt Seconds	Catalog	Manufacturer
45.00	4050	311600	PR45R4K05	PowerOhm
45.00	4400	504800	PR552-10	PowerOhm
45.00	5138	308128	552-10	PG/IPC
45.00	5850	494300	PR45R5K85	PowerOhm
45.00	6000	125000	T45R6K0	PG/IPC
45.00	6000	807700	PRT45R6K0	PowerOhm
45.00	6300	493900	PR45R6K30	PowerOhm
45.00	6750	494600	PR45R6K75	PowerOhm
45.00	7200	161500	PR555-10A	PowerOhm
45.00	8672	370410	555-10A	PG/IPC
45.00	12600	359000	T45R12K6	PG/IPC
45.00	12600	403000	PRT45R12K6	PowerOhm
45.00	12846	409420	555-10	PG/IPC
45.00	12943	409420	550-10A	PG/IPC
45.00	14580	494900	PR555-10	PowerOhm
45.00	18000	638600	PR550-10	PowerOhm
45.00	19100	656000	T45R19K1	PG/IPC
45.00	19100	794400	PRT45R19K1	PowerOhm
45.00	19427	563362	550-10	PG/IPC
44.00 Ohms				
44.00	400	8800	PF44R400W	PowerOhm
44.00	800	39400	PR4405-9A	PowerOhm
44.00	800	39500	PF44R800W	PowerOhm
44.00	1200	56400	PR4405-9	PowerOhm
44.00	1200	57700	PF44R1K20	PowerOhm
44.00	2000	99500	PR4410-9	PowerOhm
44.00	2000	126100	PF44R2K00	PowerOhm
44.00	2561	121670	442-9A	PG/IPC
44.00	2800	197400	PR442-9	PowerOhm
44.00	2800	197900	PF44R2K80	PowerOhm
44.00	3381	190604	442-9	PG/IPC
44.00	3600	79000	PF44R3K60	PowerOhm
44.00	4000	300900	PF44R4K00	PowerOhm
44.00	4800	193400	PR445-9A	PowerOhm
44.00	5600	477000	PF44R5K60	PowerOhm
44.00	5720	184031	445-9A	PG/IPC
44.00	7200	157900	PR445-9	PowerOhm
44.00	7200	793400	PF44R7K20	PowerOhm
44.00	7600	775400	PF44R7K60	PowerOhm
44.00	8454	305624	445-9	PG/IPC
44.00	8537	302807	440-9A	PG/IPC
44.00	11264	483600	PF44R11K2	PowerOhm
44.00	12784	369388	440-9	PG/IPC
44.00	14256	494900	PR440-9	PowerOhm
44.00	15000	495000	PF44R15K0	PowerOhm
44.00	23276	1263600	PF44R23K2	PowerOhm
40.00 Ohms				
40.00	300	8000	PRT40R300W	PowerOhm
40.00	300	10900	T40R300W	PG/IPC
40.00	400	8000	PF40R400W	PowerOhm
40.00	800	35900	PF40R800W	PowerOhm
40.00	900	14300	T40R900W	PG/IPC
40.00	900	51300	PRT40R900W	PowerOhm
40.00	1200	17300	T40R1K2	PG/IPC
40.00	1200	51300	PR40R1K20	PowerOhm
40.00	1200	82100	PRT40R1K2	PowerOhm
40.00	1200	83400	PF40R1K20	PowerOhm
40.00	1600	82100	PR40R1K60	PowerOhm
40.00	1800	18500	T40R1K8	PG/IPC

Ohms	Watts	Watt Seconds	Catalog	Manufacturer
40.00	1800	82100	PR40R1K80	PowerOhm
40.00	1800	109900	PRT40R1K8	PowerOhm
40.00	2000	114700	PF40R2K00	PowerOhm
40.00	3150	177100	PR40R3K15	PowerOhm
40.00	3200	277000	PF40R3K20	PowerOhm
40.00	4000	105000	T40R4K0	PG/IPC
40.00	4000	439600	PRT40R4K0	PowerOhm
40.00	4000	448800	PF40R4K00	PowerOhm
40.00	4050	273300	PR40R4K05	PowerOhm
40.00	5850	438600	PR40R5K85	PowerOhm
40.00	6000	727000	PF40R6K00	PowerOhm
40.00	7200	718000	PR40R7K20	PowerOhm
40.00	10000	309000	T40R10K0	PG/IPC
40.00	10000	403000	PRT40R10K0	PowerOhm
40.00	10240	414500	PF40R10K2	PowerOhm
40.00	10240	445700	PR40R10K2	PowerOhm
40.00	11000	333000	T40R11K0	PG/IPC
40.00	11000	403000	PRT40R11K0	PowerOhm
40.00	11429	440000	PF40R11K4	PowerOhm
40.00	16000	521000	T40R16K0	PG/IPC
40.00	16000	638700	PF40R16K0	PowerOhm
40.00	16000	649900	PRT40R16K0	PowerOhm
40.00	17000	574000	T40R17K0	PG/IPC
40.00	17000	649900	PRT40R17K0	PowerOhm
40.00	19000	568000	T40R19K0	PG/IPC
40.00	19000	649900	PRT40R19K0	PowerOhm
40.00	22000	1099600	PRT40R22K0	PowerOhm
40.00	22000	1202000	T40R22K0	PG/IPC
40.00	22858	1130600	PF40R22K8	PowerOhm
36.00 Ohms				
36.00	400	12900	PF36R400W	PowerOhm
36.00	800	32400	PF36R800W	PowerOhm
36.00	1200	77000	PF36R1K20	PowerOhm
36.00	1600	103200	PF36R1K60	PowerOhm
36.00	2000	99000	PF36R2K00	PowerOhm
36.00	2400	79200	PF36R2K40	PowerOhm
36.00	4000	395700	PF36R4K00	PowerOhm
36.00	4400	399000	PF36R4K40	PowerOhm
36.00	9216	414500	PF36R9K21	PowerOhm
36.00	11298	316618	555-11A	PG/IPC
36.00	16517	449907	555-11	PG/IPC
36.00	16863	449907	550-11A	PG/IPC
36.00	19044	1064100	PF36R19K0	PowerOhm
36.00	24978	1321116	550-11	PG/IPC
35.00 Ohms				
35.00	1200	74700	PR5505-11A	PowerOhm
35.00	2000	96100	PR5505-11	PowerOhm
35.00	2800	242300	PR5510-11A	PowerOhm
35.00	3600	392600	PR5510-11	PowerOhm
35.00	4000	153800	PR552-11A	PowerOhm
35.00	5058	157272	552-11A	PG/IPC
35.00	5600	125600	PR552-11	PowerOhm
35.00	6423	249757	552-11	PG/IPC
35.00	11340	384900	PR555-11A	PowerOhm
35.00	18515	940200	PR555-11	PowerOhm
35.00	23660	1274300	PR550-11	PowerOhm

Ohms	Watts	Watt Seconds	Catalog	Manufacturer
34.00 Ohms				
34.00	300	12200	PRT34R300W	PowerOhm
34.00	300	14700	T34R300W	PG/IPC
34.00	900	19100	T34R900W	PG/IPC
34.00	900	72700	PRT34R900W	PowerOhm
34.00	1200	72700	PR34R1K20	PowerOhm
34.00	1600	97500	PR34R1K60	PowerOhm
34.00	1800	25100	T34R1K8	PG/IPC
34.00	1800	152600	PRT34R1K8	PowerOhm
34.00	2250	93500	PR34R2K25	PowerOhm
34.00	2400	30100	T34R2K4	PG/IPC
34.00	2400	232500	PRT34R2K4	PowerOhm
34.00	3600	93000	T34R3K6	PG/IPC
34.00	3600	373700	PRT34R3K6	PowerOhm
34.00	4000	98600	T34R4K0	PG/IPC
34.00	4000	610300	PRT34R4K0	PowerOhm
34.00	4500	373700	PR34R4K50	PowerOhm
34.00	8000	262000	T34R8K0	PG/IPC
34.00	8000	345400	PRT34R8K0	PowerOhm
34.00	8704	378900	PR34R8K70	PowerOhm
34.00	9000	285000	T34R9K0	PG/IPC
34.00	9000	345400	PRT34R9K0	PowerOhm
34.00	13000	456000	T34R13K0	PG/IPC
34.00	13000	577700	PRT34R13K0	PowerOhm
34.00	13600	505000	PR34R13K6	PowerOhm
34.00	15000	456000	T34R15K0	PG/IPC
34.00	15000	577700	PRT34R15K0	PowerOhm
34.00	17000	914500	PRT34R17K0	PowerOhm
34.00	17000	990000	T34R17K0	PG/IPC
34.00	18000	914500	PRT34R18K0	PowerOhm
34.00	18000	1017000	T34R18K0	PG/IPC
34.00	19000	914500	PRT34R19K0	PowerOhm
34.00	19000	1048000	T34R19K0	PG/IPC
34.00	26000	1591000	T34R26K0	PG/IPC
34.00	26000	2360900	PRT34R26K0	PowerOhm
32.00 Ohms				
32.00	300	11400	PRT32R300W	PowerOhm
32.00	300	13800	T32R300W	PG/IPC
32.00	400	11300	PR2205-6	PowerOhm
32.00	400	11400	PF32R400W	PowerOhm
32.00	600	17500	T32R600W	PG/IPC
32.00	600	41100	PRT32R600W	PowerOhm
32.00	800	41100	PF32R800W	PowerOhm
32.00	875	35054	222-6A	PG/IPC
32.00	900	19100	T32R900W	PG/IPC
32.00	900	65700	PRT32R900W	PowerOhm
32.00	1162	55162	222-6	PG/IPC
32.00	1200	65600	PR32R1K20	PowerOhm
32.00	1200	70600	PF32R1K20	PowerOhm
32.00	1500	28100	T32R1K5	PG/IPC
32.00	1500	88000	PRT32R1K5	PowerOhm
32.00	1600	72300	PR225-6A	PowerOhm
32.00	1600	91700	PR32R1K60	PowerOhm
32.00	1600	91800	PF32R1K60	PowerOhm
32.00	1955	88573	225-6A	PG/IPC
32.00	2000	143600	PF32R2K00	PowerOhm
32.00	2100	20200	T32R2K1	PG/IPC
32.00	2100	218900	PRT32R2K1	PowerOhm
32.00	2250	143600	PR32R2K25	PowerOhm

Ohms	Watts	Watt Seconds	Catalog	Manufacturer
32.00	2400	113100	PF32R2K40	PowerOhm
32.00	2400	221500	PR225-6	PowerOhm
32.00	2700	25200	T32R2K7	PG/IPC
32.00	2700	351700	PRT32R2K7	PowerOhm
32.00	2800	220200	PF32R2K80	PowerOhm
32.00	2906	82626	225-6	PG/IPC
32.00	2918	82626	220-6A	PG/IPC
32.00	3150	218800	PR32R3K15	PowerOhm
32.00	3600	102600	PF32R3K60	PowerOhm
32.00	4000	83300	T32R4K0	PG/IPC
32.00	4000	140600	PR220-6	PowerOhm
32.00	4000	574400	PRT32R4K0	PowerOhm
32.00	4395	222215	220-6	PG/IPC
32.00	4500	105000	T32R4K5	PG/IPC
32.00	4500	574400	PRT32R4K5	PowerOhm
32.00	4800	581600	PF32R4K80	PowerOhm
32.00	4950	350600	PR32R4K95	PowerOhm
32.00	5200	583400	PF32R5K20	PowerOhm
32.00	5850	574000	PR32R5K85	PowerOhm
32.00	8192	356600	PR32R8K19	PowerOhm
32.00	8420	246000	T32R8K42	PG/IPC
32.00	8420	287800	PRT32R8K42	PowerOhm
32.00	9144	345400	PF32R9K14	PowerOhm
32.00	10368	385000	PF32R10K3	PowerOhm
32.00	12700	410000	T32R12K7	PG/IPC
32.00	12700	505500	PRT32R12K7	PowerOhm
32.00	12800	475300	PR32R12K8	PowerOhm
32.00	13545	511000	PF32R13K5	PowerOhm
32.00	17100	914500	PRT32R17K1	PowerOhm
32.00	17100	931000	T32R17K1	PG/IPC
32.00	18000	914500	PRT32R18K0	PowerOhm
32.00	18000	1017000	T32R18K0	PG/IPC
32.00	18286	931100	PF32R18K2	PowerOhm
32.00	21632	1203600	PF32R21K6	PowerOhm
32.00	26000	1591000	T32R26K0	PG/IPC
32.00	26000	2270100	PRT32R26K0	PowerOhm
32.00	27090	2541900	PF32R27K0	PowerOhm
32.00	28000	2270100	PRT32R28K0	PowerOhm
32.00	28000	2304000	T32R28K0	PG/IPC
30.00 Ohms				
30.00	260	52000	AKR2030P1K2	Rockwell
29.00 Ohms				
29.00	1200	59400	PR4405-10A	PowerOhm
29.00	1600	79600	PR4405-10	PowerOhm
29.00	2000	47300	PR4410-10A	PowerOhm
29.00	2800	325300	PR4410-10	PowerOhm
29.00	3200	127400	PR442-10A	PowerOhm
29.00	3800	127069	442-10A	PG/IPC
29.00	4800	104100	PR442-10	PowerOhm
29.00	5130	199993	442-10	PG/IPC
29.00	8487	253840	445-10A	PG/IPC
29.00	9396	274900	PR445-10A	PowerOhm
29.00	11600	447000	PR445-10	PowerOhm
29.00	12667	359925	440-10A	PG/IPC
29.00	12826	359925	445-10	PG/IPC
29.00	19396	615920	440-10	PG/IPC
29.00	19604	1061900	PR440-10	PowerOhm

Ohms	Watts	Watt Seconds	Catalog	Manufacturer
28.00 Ohms				
28.00	400	15400	PF28R400W	PowerOhm
28.00	800	35900	PF28R800W	PowerOhm
28.00	1200	57300	PF28R1K20	PowerOhm
28.00	1600	76900	PR5505-12A	PowerOhm
28.00	1600	77000	PF28R1K60	PowerOhm
28.00	2000	124100	PF28R2K00	PowerOhm
28.00	2400	79700	PR5505-12	PowerOhm
28.00	2800	314200	PF28R2K80	PowerOhm
28.00	3200	123000	PR5510-12A	PowerOhm
28.00	4000	502600	PF28R4K00	PowerOhm
28.00	4400	493600	PF28R4K40	PowerOhm
28.00	4800	100500	PR5510-12	PowerOhm
28.00	5600	320400	PF28R5K60	PowerOhm
28.00	6096	299521	552-12A	PG/IPC
28.00	7501	345400	PF28R7K50	PowerOhm
28.00	8258	237463	552-12	PG/IPC
28.00	9072	329900	PR552-12	PowerOhm
28.00	9072	330000	PF28R9K07	PowerOhm
28.00	11200	447100	PF28R11K2	PowerOhm
28.00	13615	359925	555-12A	PG/IPC
28.00	14812	752100	PR555-12A	PowerOhm
28.00	15001	846300	PF28R15K0	PowerOhm
28.00	18928	1061900	PR550-12A	PowerOhm
28.00	18928	1132700	PR555-12	PowerOhm
28.00	18928	1132800	PF28R18K9	PowerOhm
28.00	20321	1100930	550-12A	PG/IPC
28.00	20646	1033301	555-12	PG/IPC
28.00	23548	2224200	PF28R23K5	PowerOhm
28.00	28672	3042500	PR550-12	PowerOhm
28.00	30001	3042600	PF28R30K0	PowerOhm
28.00	30492	2138364	550-12	PG/IPC
28.00	36288	4610000	PF28R36K2	PowerOhm
27.00 Ohms				
27.00	300	15400	PRT27R300W	PowerOhm
27.00	300	18500	T27R300W	PG/IPC
27.00	600	15400	T27R600W	PG/IPC
27.00	600	34700	PRT27R600W	PowerOhm
27.00	800	34700	PR27R800W	PowerOhm
27.00	900	24900	T27R900W	PG/IPC
27.00	900	55400	PRT27R900W	PowerOhm
27.00	1200	18800	T27R1K2	PG/IPC
27.00	1200	55400	PR27R1K20	PowerOhm
27.00	1200	74200	PRT27R1K2	PowerOhm
27.00	1500	23700	T27R1K5	PG/IPC
27.00	1500	119600	PRT27R1K5	PowerOhm
27.00	1600	74200	PR27R1K60	PowerOhm
27.00	2100	27300	T27R2K1	PG/IPC
27.00	2100	302900	PRT27R2K1	PowerOhm
27.00	3300	73900	T27R3K3	PG/IPC
27.00	3300	484700	PRT27R3K3	PowerOhm
27.00	3600	296300	PR27R3K60	PowerOhm
27.00	6912	300700	PR27R6K91	PowerOhm
27.00	8420	346700	PRT27R8K42	PowerOhm
27.00	8420	358000	T27R8K42	PG/IPC
27.00	10800	401100	PR27R10K8	PowerOhm
27.00	11500	391000	T27R11K5	PG/IPC
27.00	11500	433300	PRT27R11K5	PowerOhm
27.00	15000	731600	PRT27R15K0	PowerOhm

Ohms	Watts	Watt Seconds	Catalog	Manufacturer
27.00	15000	931000	T27R15K0	PG/IPC
27.00	21600	1346000	T27R21K6	PG/IPC
27.00	21600	1906900	PRT27R21K6	PowerOhm
27.00	27400	2075000	T27R27K4	PG/IPC
27.00	27400	2833000	PRT27R27K4	PowerOhm
25.00 Ohms				
25.00	250	14300	PR25R250W	PowerOhm
25.00	300	14300	PRT25R300W	PowerOhm
25.00	300	17200	T25R300W	PG/IPC
25.00	400	13800	PF25R400W	PowerOhm
25.00	400	14300	PR25R400W	PowerOhm
25.00	600	14300	T25R600W	PG/IPC
25.00	600	53500	PRT25R600W	PowerOhm
25.00	800	53500	PR25R800W	PowerOhm
25.00	800	55600	PF25R800W	PowerOhm
25.00	900	23000	T25R900W	PG/IPC
25.00	900	71700	PRT25R900W	PowerOhm
25.00	1200	27700	T25R1K2	PG/IPC
25.00	1200	71400	PF25R1K20	PowerOhm
25.00	1200	71700	PR25R1K20	PowerOhm
25.00	1200	112200	PRT25R1K2	PowerOhm
25.00	1500	22000	T25R1K5	PG/IPC
25.00	1500	173100	PRT25R1K5	PowerOhm
25.00	1600	55000	PF25R1K60	PowerOhm
25.00	1800	112200	PR25R1K80	PowerOhm
25.00	2000	173100	PF25R2K00	PowerOhm
25.00	2400	130800	PF25R2K40	PowerOhm
25.00	2700	280000	PR25R2K70	PowerOhm
25.00	2800	277000	PF25R2K80	PowerOhm
25.00	3150	274700	PR25R3K15	PowerOhm
25.00	3200	272600	PF25R3K20	PowerOhm
25.00	3300	73900	T25R3K3	PG/IPC
25.00	3300	448800	PRT25R3K3	PowerOhm
25.00	3900	190000	T25R3K9	PG/IPC
25.00	3900	448800	PRT25R3K9	PowerOhm
25.00	6400	278600	PR25R6K40	PowerOhm
25.00	6876	276400	PF25R6K87	PowerOhm
25.00	8420	288900	PRT25R8K42	PowerOhm
25.00	8420	328000	T25R8K42	PG/IPC
25.00	10000	371400	PR25R10K0	PowerOhm
25.00	10158	383200	PF25R10K1	PowerOhm
25.00	13751	752200	PF25R13K7	PowerOhm
25.00	16900	962500	PR25R16K9	PowerOhm
25.00	21025	2012300	PF25R21K0	PowerOhm
25.00	25600	2789000	PF25R25K6	PowerOhm
25.00	32400	4149000	PF25R32K4	PowerOhm
25.00	40632	1445600	PF25R40K6	PowerOhm
25.00	55001	2926300	PF25R55K0	PowerOhm
24.00 Ohms				
24.00	2000	166100	PR5505-13A	PowerOhm
24.00	2800	105400	PR5505-13	PowerOhm
24.00	3600	86100	PR5510-13A	PowerOhm
24.00	5600	430700	PR5510-13	PowerOhm
24.00	7340	211079	552-13A	PG/IPC
24.00	7776	274900	PR552-13A	PowerOhm
24.00	9600	383100	PR552-13	PowerOhm
24.00	9635	299938	552-13	PG/IPC
24.00	16224	900800	PR555-13A	PowerOhm
24.00	16393	533797	555-13A	PG/IPC

Ohms	Watts	Watt Seconds	Catalog	Manufacturer
24.00	20184	1906300	PR555-13	PowerOhm
24.00	24086	1173670	555-13	PG/IPC
24.00	24468	1871068	550-13A	PG/IPC
24.00	24576	2662200	PR550-13A	PowerOhm
24.00	31104	3995200	PR550-13	PowerOhm
24.00	36710	844315	550-13	PG/IPC
23.00 Ohms				
23.00	250	20700	PR23R250W	PowerOhm
23.00	300	13200	PRT23R300W	PowerOhm
23.00	300	15800	T23R300W	PG/IPC
23.00	400	20700	PR23R400W	PowerOhm
23.00	600	20800	T23R600W	PG/IPC
23.00	600	49200	PRT23R600W	PowerOhm
23.00	800	49200	PR23R800W	PowerOhm
23.00	800	51300	PF23R800W	PowerOhm
23.00	900	21300	T23R900W	PG/IPC
23.00	900	63200	PRT23R900W	PowerOhm
23.00	1200	63100	PR4405-11A	PowerOhm
23.00	1200	63200	PR23R1K20	PowerOhm
23.00	1200	63500	PF23R1K20	PowerOhm
23.00	1500	20200	T23R1K5	PG/IPC
23.00	1500	157300	PRT23R1K5	PowerOhm
23.00	1600	82600	PF23R1K60	PowerOhm
23.00	2000	65500	PR4405-11	PowerOhm
23.00	2000	157300	PF23R2K00	PowerOhm
23.00	2100	23100	T23R2K1	PG/IPC
23.00	2100	252800	PRT23R2K1	PowerOhm
23.00	2250	157300	PR23R2K25	PowerOhm
23.00	2400	258000	PR4410-11A	PowerOhm
23.00	3150	252400	PR23R3K15	PowerOhm
23.00	3600	82500	PR4410-11	PowerOhm
23.00	3600	185800	PF23R3K60	PowerOhm
23.00	4000	82500	PR442-11A	PowerOhm
23.00	4982	254295	442-11A	PG/IPC
23.00	6310	179000	T23R6K31	PG/IPC
23.00	6310	230300	PRT23R6K31	PowerOhm
23.00	6469	399830	442-11	PG/IPC
23.00	7452	275000	PF23R7K45	PowerOhm
23.00	7452	281600	PR442-11	PowerOhm
23.00	7490	288900	PRT23R7K49	PowerOhm
23.00	7490	328000	T23R7K49	PG/IPC
23.00	10200	310000	T23R10K2	PG/IPC
23.00	10200	361100	PRT23R10K2	PowerOhm
23.00	11125	492736	445-11A	PG/IPC
23.00	12167	658100	PR445-11A	PowerOhm
23.00	15548	900800	PR445-11	PowerOhm
23.00	15548	900900	PF23R15K5	PowerOhm
23.00	16172	825698	445-11	PG/IPC
23.00	23552	2535400	PR440-11	PowerOhm
23.00	29808	3841600	PF23R29K8	PowerOhm
22.00 Ohms				
22.00	1200	28200	PR22R1K20	PowerOhm
22.00	1600	45200	PR22R1K60	PowerOhm
22.00	2700	63000	PR22R2K70	PowerOhm
22.00	5632	245000	PR22R5K63	PowerOhm
22.00	11638	626900	PR22R11K6	PowerOhm
22.00	14872	847000	PR22R14K8	PowerOhm

Ohms	Watts	Watt Seconds	Catalog	Manufacturer
21.00 Ohms				
21.00	400	18900	PF21R400W	PowerOhm
21.00	800	47100	PF21R800W	PowerOhm
21.00	1200	57700	PF21R1K20	PowerOhm
21.00	1600	75400	PF21R1K60	PowerOhm
21.00	2000	143600	PF21R2K00	PowerOhm
21.00	2400	107700	PF21R2K40	PowerOhm
21.00	3200	373400	PF21R3K20	PowerOhm
21.00	4000	240800	PF21R4K00	PowerOhm
21.00	5626	236100	PF21R5K62	PowerOhm
21.00	7426	234800	PF21R7K42	PowerOhm
21.00	8400	319400	PF21R8K40	PowerOhm
21.00	11251	564200	PF21R11K2	PowerOhm
21.00	17661	1694600	PF21R17K6	PowerOhm
21.00	22501	2282000	PF21R22K5	PowerOhm
21.00	33600	5992900	PF21R33K6	PowerOhm
21.00	45001	2394200	PF21R45K0	PowerOhm
21.00	70644	6778300	PF21R70K6	PowerOhm
20.00 Ohms				
20.00	300	13700	T20R300W	PG/IPC
20.00	300	18000	PRT20R300W	PowerOhm
20.00	400	17900	PR2205-7A	PowerOhm
20.00	600	17300	T20R600W	PG/IPC
20.00	600	41100	PRT20R600W	PowerOhm
20.00	800	41000	PR2205-7	PowerOhm
20.00	900	18500	T20R900W	PG/IPC
20.00	900	55000	PRT20R900W	PowerOhm
20.00	1200	54900	PR20R1K20	PowerOhm
20.00	1372	87086	222-7A	PG/IPC
20.00	1500	28000	T20R1K5	PG/IPC
20.00	1500	224400	PRT20R1K5	PowerOhm
20.00	1600	138400	PR222-7	PowerOhm
20.00	1600	138500	PR20R1K60	PowerOhm
20.00	1860	55084	222-7	PG/IPC
20.00	2250	224400	PR20R2K25	PowerOhm
20.00	2400	87900	PR225-7A	PowerOhm
20.00	3063	138493	225-7A	PG/IPC
20.00	4000	358900	PR225-7	PowerOhm
20.00	4572	222215	220-7A	PG/IPC
20.00	4650	221432	225-7	PG/IPC
20.00	5120	222800	PR20R5K12	PowerOhm
20.00	5940	231100	PRT20R5K94	PowerOhm
20.00	5940	260000	T20R5K94	PG/IPC
20.00	6480	219900	PR220-7	PowerOhm
20.00	7031	169227	220-7	PG/IPC
20.00	8000	297100	PR20R8K00	PowerOhm
20.00	8920	267000	T20R8K92	PG/IPC
20.00	8920	361100	PRT20R8K92	PowerOhm
20.00	10700	548700	PRT20R10K7	PowerOhm
20.00	10700	582000	T20R10K7	PG/IPC
20.00	13520	770000	PR20R13K5	PowerOhm
20.00	15200	924000	T20R15K2	PG/IPC
20.00	15200	1452900	PRT20R15K2	PowerOhm
20.00	16605	825698	440-11A	PG/IPC
20.00	20600	1602000	T20R20K6	PG/IPC
20.00	20600	2124800	PRT20R20K6	PowerOhm
20.00	24910	1781970	440-11	PG/IPC
20.00	28400	1066000	T20R28K4	PG/IPC
20.00	28400	4815100	PRT20R28K4	PowerOhm

Ohms	Watts	Watt Seconds	Catalog	Manufacturer
20.00	34600	1148000	T20R34K6	PG/IPC
20.00	34600	4815100	PRT20R34K6	PowerOhm
19.00 Ohms				
19.00	400	17100	PF19R400W	PowerOhm
19.00	800	39000	PF19R800W	PowerOhm
19.00	1200	84900	PF19R1K20	PowerOhm
19.00	1200	85300	PR19R1K20	PowerOhm
19.00	1600	68300	PF19R1K60	PowerOhm
19.00	2000	213200	PF19R2K00	PowerOhm
19.00	2250	208800	PR19R2K25	PowerOhm
19.00	2400	83500	PR5505-14A	PowerOhm
19.00	2700	208400	PR19R2K70	PowerOhm
19.00	2800	339300	PF19R2K80	PowerOhm
19.00	3200	68200	PR5505-14	PowerOhm
19.00	3200	344700	PF19R3K20	PowerOhm
19.00	4864	207200	PR5510-14A	PowerOhm
19.00	4864	207300	PF19R4K86	PowerOhm
19.00	6716	220000	PF19R6K71	PowerOhm
19.00	6859	213300	PR19R6K85	PowerOhm
19.00	7600	272500	PR5510-14	PowerOhm
19.00	8213	272600	PF19R8K21	PowerOhm
19.00	9540	410613	552-14A	PG/IPC
19.00	10051	564100	PR552-14A	PowerOhm
19.00	10051	564200	PF19R10K0	PowerOhm
19.00	12170	410613	552-14	PG/IPC
19.00	12844	731500	PR19R12K8	PowerOhm
19.00	12844	800700	PR552-14	PowerOhm
19.00	13613	700700	PF19R13K6	PowerOhm
19.00	16425	1497400	PF19R16K4	PowerOhm
19.00	19456	2028300	PR555-14A	PowerOhm
19.00	19456	2131600	PR19R19K4	PowerOhm
19.00	19456	2155200	PF19R19K4	PowerOhm
19.00	21305	1514674	555-14A	PG/IPC
19.00	30400	5393500	PR555-14	PowerOhm
19.00	30400	5393600	PF19R30K4	PowerOhm
19.00	31798	3029900	550-14A	PG/IPC
19.00	31965	2913365	555-14	PG/IPC
19.00	40204	2128200	PF19R40K2	PowerOhm
19.00	47500	10656500	PR550-14	PowerOhm
19.00	47709	5953399	550-14	PG/IPC
19.00	63916	6142800	PF19R63K9	PowerOhm
19.00	77824	8113500	PF19R77K8	PowerOhm
18.00 Ohms				
18.00	1600	23100	PR18R1K60	PowerOhm
18.00	1600	51200	PR4405-12A	PowerOhm
18.00	1800	123100	PR18R1K80	PowerOhm
18.00	2250	197800	PR18R2K25	PowerOhm
18.00	2400	79100	PR4405-12	PowerOhm
18.00	2700	197800	PR18R2K70	PowerOhm
18.00	3150	322900	PR18R3K15	PowerOhm
18.00	3200	323000	PR4410-12A	PowerOhm
18.00	3600	323100	PR18R3K60	PowerOhm
18.00	4608	195800	PR4410-12	PowerOhm
18.00	4608	200600	PR18R4K60	PowerOhm
18.00	5832	219900	PR442-12A	PowerOhm
18.00	6184	152850	442-12A	PG/IPC
18.00	6498	202100	PR18R6K49	PowerOhm
18.00	7200	267400	PR18R7K20	PowerOhm
18.00	8266	234734	442-12	PG/IPC

Ohms	Watts	Watt Seconds	Catalog	Manufacturer
18.00	9522	512900	PR18R9K52	PowerOhm
18.00	9522	564100	PR442-12	PowerOhm
18.00	12168	693000	PR18R12K1	PowerOhm
18.00	13810	660558	445-12A	PG/IPC
18.00	15138	1480900	PR18R15K1	PowerOhm
18.00	15138	1497300	PR445-12A	PowerOhm
18.00	18432	2019400	PR18R18K4	PowerOhm
18.00	18432	2028300	PR445-12	PowerOhm
18.00	20612	1336477	440-12A	PG/IPC
18.00	20664	1336477	445-12	PG/IPC
18.00	23328	3006500	PR18R23K3	PowerOhm
18.00	28800	4994000	PR440-12	PowerOhm
18.00	28800	5136800	PR18R28K8	PowerOhm
18.00	30910	899814	440-12	PG/IPC
15.40 Ohms				
15.40	800	42400	PF15F4R800W	PowerOhm
15.40	1200	106000	PF15F4R1K20	PowerOhm
15.40	1600	172800	PR15F4R1K60	PowerOhm
15.40	2250	276500	PR15F4R2K25	PowerOhm
15.40	2400	123100	PF15F4R2K40	PowerOhm
15.40	3600	275700	PR15F4R3K60	PowerOhm
15.40	5063	165000	PF15F4R5K06	PowerOhm
15.40	8146	438800	PR15F4R8K14	PowerOhm
15.40	10410	600600	PF15F4R10K4	PowerOhm
15.40	12951	1267000	PR15F4R12K9	PowerOhm
15.40	19958	2572200	PR15F4R19K9	PowerOhm
15.40	20251	2612300	PF15F4R20K2	PowerOhm
15.40	41642	2407200	PF15F4R41K6	PowerOhm
15.00 Ohms				
15.00	300	16400	T15R300W	PG/IPC
15.00	300	19300	PRT15R300W	PowerOhm
15.00	400	19300	PR15R400W	PowerOhm
15.00	520	104000	2-AKR2030P1K2	Rockwell
15.00	600	20800	T15R600W	PG/IPC
15.00	600	41300	PRT15R600W	PowerOhm
15.00	800	41300	PR15R800W	PowerOhm
15.00	900	22000	T15R900W	PG/IPC
15.00	900	103900	PRT15R900W	PowerOhm
15.00	1500	38800	T15R1K5	PG/IPC
15.00	1500	164900	PRT15R1K5	PowerOhm
15.00	1600	164900	PR15R1K60	PowerOhm
15.00	2000	65900	PR4405-13A	PowerOhm
15.00	2800	269200	PR4405-13	PowerOhm
15.00	3150	268900	PR15R3K15	PowerOhm
15.00	3840	177000	PR4410-13A	PowerOhm
15.00	4210	122400	PRT15R4K21	PowerOhm
15.00	4210	143000	T15R4K21	PG/IPC
15.00	4860	164900	PR5505-15	PowerOhm
15.00	4860	168400	PR15R4K86	PowerOhm
15.00	6000	218000	PR4410-13	PowerOhm
15.00	6160	232000	T15R6K16	PG/IPC
15.00	6160	288900	PRT15R6K16	PowerOhm
15.00	7132	179963	442-13A	PG/IPC
15.00	7935	401300	PR442-13A	PowerOhm
15.00	8570	457300	PRT15R8K57	PowerOhm
15.00	8570	466000	T15R8K57	PG/IPC
15.00	9919	328491	442-13	PG/IPC
15.00	10140	600500	PR442-13	PowerOhm
15.00	11400	734000	T15R11K4	PG/IPC

Ohms	Watts	Watt Seconds	Catalog	Manufacturer
15.00	11400	1027000	PRT15R11K4	PowerOhm
15.00	12112	550465	552-15A	PG/IPC
15.00	12615	1197800	PR552-15A	PowerOhm
15.00	15360	1613000	PR552-15	PowerOhm
15.00	15360	1648000	PR445-13A	PowerOhm
15.00	15927	1158280	445-13A	PG/IPC
15.00	18173	1158280	552-15	PG/IPC
15.00	23772	719851	440-13A	PG/IPC
15.00	23894	719851	445-13	PG/IPC
15.00	24000	3995200	PR445-13	PowerOhm
15.00	24000	4195000	PR440-13A	PowerOhm
15.00	27060	719851	555-15A	PG/IPC
15.00	35663	1313963	440-13	PG/IPC
15.00	37500	7571700	PR440-13	PowerOhm
15.00	40388	1300276	550-15A	PG/IPC
15.00	40587	1313963	555-15	PG/IPC
15.00	60579	7591398	550-15	PG/IPC
15.00	73500	17841500	PR550-15	PowerOhm
14.00 Ohms				
14.00	300	15400	T14R300W	PG/IPC
14.00	300	18000	PRT14R300W	PowerOhm
14.00	400	18000	PR14R400W	PowerOhm
14.00	600	19400	T14R600W	PG/IPC
14.00	600	38500	PRT14R600W	PowerOhm
14.00	800	38400	PR2205-8	PowerOhm
14.00	800	38500	PR14R800W	PowerOhm
14.00	900	20700	T14R900W	PG/IPC
14.00	900	95800	PRT14R900W	PowerOhm
14.00	1200	24500	T14R1K2	PG/IPC
14.00	1200	39800	PR2210-8A	PowerOhm
14.00	1200	153900	PRT14R1K2	PowerOhm
14.00	1600	61500	PR2210-8	PowerOhm
14.00	1800	27800	T14R1K8	PG/IPC
14.00	1800	153900	PR14R1K80	PowerOhm
14.00	1800	251300	PRT14R1K8	PowerOhm
14.00	2012	61344	222-8A	PG/IPC
14.00	2400	50200	PR222-8	PowerOhm
14.00	2657	154455	222-8	PG/IPC
14.00	3150	251300	PR14R3K15	PowerOhm
14.00	4495	117367	225-8A	PG/IPC
14.00	4536	157200	PR14R4K53	PowerOhm
14.00	4536	164900	PR225-8A	PowerOhm
14.00	6160	216700	PRT14R6K16	PowerOhm
14.00	6160	232000	T14R6K16	PG/IPC
14.00	6642	172138	225-8	PG/IPC
14.00	6708	172138	220-8A	PG/IPC
14.00	7406	376000	PR225-8	PowerOhm
14.00	9464	600500	PR220-8	PowerOhm
14.00	10045	523728	220-8	PG/IPC
14.00	11400	734000	T14R11K4	PG/IPC
14.00	11400	1027000	PRT14R11K4	PowerOhm
14.00	12700	1027000	PRT14R12K7	PowerOhm
14.00	12700	1038000	T14R12K7	PG/IPC
13.00 Ohms				
13.00	400	27800	PR13R400W	PowerOhm
13.00	800	58400	PF13R800W	PowerOhm
13.00	1200	88900	PR13R1K20	PowerOhm
13.00	1600	111200	PF13R1K60	PowerOhm
13.00	2250	233400	PR13R2K25	PowerOhm

Ohms	Watts	Watt Seconds	Catalog	Manufacturer
13.00	2800	238800	PF13R2K80	PowerOhm
13.00	3328	144900	PR13R3K32	PowerOhm
13.00	5200	193100	PR13R5K20	PowerOhm
13.00	5457	191600	PF13R5K45	PowerOhm
13.00	11000	1048200	PF13R11K0	PowerOhm
12.00 Ohms				
12.00	400	82100	PR12R400W	PowerOhm
12.00	800	131900	PR12R800W	PowerOhm
12.00	1200	134700	PR12R1K20	PowerOhm
12.00	2250	215400	PR12R2K25	PowerOhm
12.00	2400	215300	PR4405-14A	PowerOhm
12.00	3072	133600	PR12R3K07	PowerOhm
12.00	3888	140800	PR5505-16A	PowerOhm
12.00	3888	155500	PR4405-14	PowerOhm
12.00	4800	191500	PR4410-14A	PowerOhm
12.00	6348	342000	PR12R6K34	PowerOhm
12.00	6348	376000	PR5505-16	PowerOhm
12.00	8112	500400	PR4410-14	PowerOhm
12.00	9641	440372	442-14A	PG/IPC
12.00	10092	898400	PR442-14A	PowerOhm
12.00	10092	1048100	PR5510-16	PowerOhm
12.00	12288	1433800	PR552-16A	PowerOhm
12.00	12398	890985	442-14	PG/IPC
12.00	13780	890985	552-16A	PG/IPC
12.00	15552	1955200	PR442-14	PowerOhm
12.00	19200	3595700	PR552-16	PowerOhm
12.00	20673	599876	552-16	PG/IPC
12.00	21531	1924486	445-14A	PG/IPC
12.00	24300	3941400	PR445-14A	PowerOhm
12.00	30000	6169500	PR445-14	PowerOhm
12.00	30000	6450000	PR555-16A	PowerOhm
12.00	30776	1040221	555-16A	PG/IPC
12.00	32136	1040221	440-14A	PG/IPC
12.00	32297	1040221	445-14	PG/IPC
12.00	43200	10984300	PR555-16	PowerOhm
12.00	45934	2387466	550-16A	PG/IPC
12.00	46170	2247026	555-16	PG/IPC
12.00	48204	1314510	440-14	PG/IPC
12.00	58800	16476500	PR440-14	PowerOhm
12.00	68911	10015318	550-16	PG/IPC
12.00	86700	28607000	PR550-16	PowerOhm
11.00 Ohms				
11.00	800	17900	PR2205-9A	PowerOhm
11.00	1200	48300	PR2205-9	PowerOhm
11.00	1600	39400	PR2210-9A	PowerOhm
11.00	2000	197400	PR2210-9	PowerOhm
11.00	2400	197400	PR222-9A	PowerOhm
11.00	2561	121123	222-9A	PG/IPC
11.00	3381	100080	222-9	PG/IPC
11.00	3564	116600	PR222-9	PowerOhm
11.00	5720	237243	225-9A	PG/IPC
11.00	5819	321000	PR225-9A	PowerOhm
11.00	8454	407344	225-9	PG/IPC
11.00	8537	407344	220-9A	PG/IPC
11.00	9251	898400	PR225-9	PowerOhm
11.00	12784	890985	220-9	PG/IPC
11.00	14256	1737900	PR220-9	PowerOhm

Ohms	Watts	Watt Seconds	Catalog	Manufacturer
10.40 Ohms				
10.40	300	17300	T10F4R300W	PG/IPC
10.40	300	21400	PRT10F4R300W	PowerOhm
10.40	600	22900	T10F4R600W	PG/IPC
10.40	600	46100	PRT10F4R600W	PowerOhm
10.40	900	24500	T10F4R900W	PG/IPC
10.40	900	114300	PRT10F4R900W	PowerOhm
10.40	1500	25400	T10F4R1K5	PG/IPC
10.40	1500	186700	PRT10F4R1K5	PowerOhm
10.40	1800	186700	PR10F4R1K80	PowerOhm
10.40	2662	115900	PR10F4R2K66	PowerOhm
10.40	2970	81600	PRT10F4R2K97	PowerOhm
10.40	2970	95100	T10F4R2K97	PG/IPC
10.40	4160	153300	PR10F4R4K16	PowerOhm
10.40	5360	274400	PRT10F4R5K36	PowerOhm
10.40	5360	329000	T10F4R5K36	PG/IPC
10.40	6040	274400	PRT10F4R6K4	PowerOhm
10.40	6040	489000	T10F4R6K4	PG/IPC
10.40	8746	855700	PR10F4R8K74	PowerOhm
10.40	8890	770300	PRT10F4R8K89	PowerOhm
10.40	8890	801000	T10F4R8K89	PG/IPC
10.40	11000	359000	T10F4R11K0	PG/IPC
10.40	11000	1168200	PRT10F4R11K0	PowerOhm
10.40	15500	1742000	T10F4R15K5	PG/IPC
10.40	15500	2490600	PRT10F4R15K5	PowerOhm
10.40	16640	2966900	PR10F4R16K6	PowerOhm
10.40	18900	1991000	T10F4R18K9	PG/IPC
10.40	18900	3790000	PRT10F4R18K9	PowerOhm
10.40	26000	2002000	T10F4R26K0	PG/IPC
10.40	26000	5718700	PR10F4R26K0	PowerOhm
10.40	26000	5885300	PRT10F4R26K0	PowerOhm
10.40	35600	1230000	T10F4R35K6	PG/IPC
10.40	35600	10024700	PRT10F4R35K6	PowerOhm
10.40	43900	1367000	T10F4R43K9	PG/IPC
10.40	43900	14328100	PRT10F4R43K9	PowerOhm
10.40	72300	4620000	T10F4R72K3	PG/IPC
10.40	72300	18257600	PRT10F4R72K3	PowerOhm
10.10 Ohms				
10.10	400	20600	PF10F1R400W	PowerOhm
10.10	800	35900	PF10F1R800W	PowerOhm
10.10	1200	112100	PF10F1R1K20	PowerOhm
10.00	4000	163500	PR5505-17A	PowerOhm
10.00	6760	400300	PR5505-17	PowerOhm
10.00	8410	898400	PR5510-17A	PowerOhm
10.00	12960	1737900	PR5510-17	PowerOhm
10.00	16000	2824200	PR552-17A	PowerOhm
10.00	17713	479901	552-17A	PG/IPC
10.00	25000	5328200	PR552-17	PowerOhm
10.00	26569	903350	552-17	PG/IPC
10.00	36000	8787400	PR555-17A	PowerOhm
10.00	39559	1956117	555-17A	PG/IPC
10.00	49000	13730400	PR550-17A	PowerOhm
10.00	51840	6453800	PR555-17	PowerOhm
10.00	59043	1950414	550-17A	PG/IPC
10.00	59339	1950414	555-17	PG/IPC
9.50 Ohms				
9.50	3800	135500	PR4405-15A	PowerOhm
9.50	5025	266000	PR4405-15	PowerOhm
9.50	6422	400300	PR4410-15A	PowerOhm

Ohms	Watts	Watt Seconds	Catalog	Manufacturer
9.50	9728	1075300	PR4410-15	PowerOhm
9.50	11926	316618	442-15A	PG/IPC
9.50	12312	1520700	PR442-15A	PowerOhm
9.50	15200	2596900	PR442-15	PowerOhm
9.50	17890	479901	442-15	PG/IPC
9.50	23750	5047800	PR445-15A	PowerOhm
9.50	26636	3000513	445-15A	PG/IPC
9.50	34200	8787400	PR445-15	PowerOhm
9.50	38912	4056700	PR440-15A	PowerOhm
9.50	39755	2851152	440-15A	PG/IPC
9.50	39955	1079776	445-15	PG/IPC
9.50	49248	6146500	PR440-15	PowerOhm
9.50	59635	1820386	440-15	PG/IPC
9.20 Ohms				
9.20	400	18900	PF9F2R400W	PowerOhm
9.20	800	32400	PF9F2R800W	PowerOhm
9.20	1200	102200	PF9F2R1K20	PowerOhm
9.20	1600	75500	PF9F2R1K60	PowerOhm
9.20	2000	161600	PF9F2R2K00	PowerOhm
9.20	2355	98000	PF9F2R2K35	PowerOhm
9.20	2981	116700	PF9F2R2K98	PowerOhm
9.20	3751	135600	PF9F2R3K75	PowerOhm
9.20	4867	282100	PF9F2R4K86	PowerOhm
9.20	6601	341800	PF9F2R6K60	PowerOhm
9.20	7737	748700	PF9F2R7K73	PowerOhm
9.20	9421	1075400	PF9F2R9K42	PowerOhm
9.20	11923	1520800	PF9F2R11K9	PowerOhm
9.20	15001	545200	PF9F2R15K0	PowerOhm
9.20	19467	1064100	PF9F2R19K4	PowerOhm
9.20	24876	1416000	PF9F2R24K8	PowerOhm
9.20	30948	2965500	PF9F2R30K9	PowerOhm
9.20	37683	4056800	PF9F2R37K6	PowerOhm
9.20	47693	6146600	PF9F2R47K6	PowerOhm
9.20	58880	10387700	PF9F2R58K8	PowerOhm
9.20	69635	6672400	PF9F2R69K6	PowerOhm
9.20	90001	9127700	PF9F2R90K0	PowerOhm
9.20	132480	23372300	PF9F2R132K2	PowerOhm
8.00 Ohms				
8.00	4232	240700	PR4405-16A	PowerOhm
8.00	5408	300200	PR4405-16	PowerOhm
8.00	8192	896100	PR4410-16A	PowerOhm
8.00	10368	1303400	PR4410-16	PowerOhm
8.00	14093	401656	442-16A	PG/IPC
8.00	16200	2786200	PR442-16A	PowerOhm
8.00	16200	2846600	PR442-16	PowerOhm
8.00	21143	693480	442-16	PG/IPC
8.00	23427	1211023	552-18A	PG/IPC
8.00	28800	7322900	PR445-16A	PowerOhm
8.00	31474	1564893	445-16A	PG/IPC
8.00	35138	2494758	552-18	PG/IPC
8.00	39200	10984300	PR552-18	PowerOhm
8.00	41472	4917200	PR445-16	PowerOhm
8.00	46977	2966898	440-16A	PG/IPC
8.00	47219	1560331	445-16	PG/IPC
8.00	52321	1559677	555-18A	PG/IPC
8.00	57800	19071300	PR555-18A	PowerOhm
8.00	64800	10510600	PR440-16	PowerOhm
8.00	70477	3325398	440-16	PG/IPC
8.00	78475	5345909	555-18	PG/IPC

Ohms	Watts	Watt Seconds	Catalog	Manufacturer
8.00	80000	15704400	PR555-18	PowerOhm
7.30 Ohms				
7.30	1200	26200	PR2205-10A	PowerOhm
7.30	1600	131000	PR2205-10	PowerOhm
7.30	1868	77700	PR2210-10A	PowerOhm
7.30	2920	107400	PR2210-10	PowerOhm
7.30	3826	164245	222-10A	PG/IPC
7.30	3861	199500	PR222-10A	PowerOhm
7.30	5095	267369	222-10	PG/IPC
7.30	6139	598900	PR222-10	PowerOhm
7.30	7475	896100	PR225-10A	PowerOhm
7.30	8545	566990	225-10A	PG/IPC
7.30	11680	2259300	PR225-10	PowerOhm
7.30	12738	359925	225-10	PG/IPC
7.30	12754	359925	220-10A	PG/IPC
7.30	14782	2476600	PR220-10A	PowerOhm
7.30	18250	3964700	PR220-10	PowerOhm
7.30	19264	656981	220-10	PG/IPC
7.00 Ohms				
7.00	400	19300	PF7R400W	PowerOhm
7.00	1200	123900	PF7R1K20	PowerOhm
7.00	1600	77000	PF7R1K60	PowerOhm
7.00	1792	77800	PR7R1K79	PowerOhm
7.00	2800	107500	PF7R2K80	PowerOhm
7.00	4732	269500	PR7R4K73	PowerOhm
7.00	7383	765100	PF7R7K38	PowerOhm
7.00	11251	436200	PF7R11K2	PowerOhm
7.00	14812	802700	PF7R14K8	PowerOhm
7.00	23548	2330100	PF7R23K5	PowerOhm
7.00	36912	4610000	PF7R36K9	PowerOhm
7.00	55001	5083700	PF7R55K0	PowerOhm
7.00	81648	10141900	PF7R81K6	PowerOhm
7.00	127575	21021300	PF7R127K7	PowerOhm
7.00	157500	34493700	PF7R157K7	PowerOhm
6.50 Ohms				
6.50	2106	92600	PF6F5R2K10	PowerOhm
6.50	2600	90400	PF6F5R2K60	PowerOhm
6.50	3438	188100	PF6F5R3K43	PowerOhm
6.50	4394	256400	PF6F5R4K39	PowerOhm
6.50	5466	599000	PF6F5R5K46	PowerOhm
6.50	6656	717000	PF6F5R6K65	PowerOhm
6.50	8424	1086300	PF6F5R8K42	PowerOhm
6.40 Ohms				
6.40	4326	256300	PR4405-17A	PowerOhm
6.40	6553	716900	PR4405-17	PowerOhm
6.40	8294	1086200	PR4410-17A	PowerOhm
6.40	12960	2167000	PR4410-17	PowerOhm
6.40	16000	3568300	PR442-17A	PowerOhm
6.40	17529	574859	442-17A	PG/IPC
6.40	23040	5858300	PR442-17	PowerOhm
6.40	26292	719851	442-17	PG/IPC
6.40	33177	4302500	PR445-17A	PowerOhm
6.40	39148	1231840	445-17A	PG/IPC
6.40	58430	4818224	440-17A	PG/IPC
6.40	58718	4929414	445-17	PG/IPC
6.40	64000	13460900	PR445-17	PowerOhm

Ohms	Watts	Watt Seconds	Catalog	Manufacturer
6.00 Ohms				
6.00	7776	1086200	PR5505-19A	PowerOhm
6.00	12150	1857400	PR5505-19	PowerOhm
6.00	15000	3171800	PR5510-19A	PowerOhm
6.00	21600	5176500	PR5510-19	PowerOhm
6.00	28008	1960167	552-19A	PG/IPC
6.00	29400	8238200	PR552-19A	PowerOhm
6.00	38400	6392400	PR552-19	PowerOhm
6.00	42015	1981674	552-19	PG/IPC
6.00	60000	12900000	PR555-19A	PowerOhm
6.00	62551	2135190	555-19A	PG/IPC
5.70 Ohms				
5.70	1600	8200	PR2205-11A	PowerOhm
5.70	1846	61700	PR2205-11	PowerOhm
5.70	2280	90300	PR2210-11A	PowerOhm
5.70	3853	212300	PR2210-11	PowerOhm
5.70	4793	449200	PR222-11A	PowerOhm
5.70	4938	260816	222-11A	PG/IPC
5.70	5836	612000	PR222-11	PowerOhm
5.70	6525	421193	222-11	PG/IPC
5.70	11029	905640	225-11A	PG/IPC
5.70	11542	1857400	PR225-11A	PowerOhm
5.70	16314	880744	225-11	PG/IPC
5.70	16461	880744	220-11A	PG/IPC
5.70	20520	5176500	PR225-11	PowerOhm
5.70	24694	1781970	220-11	PG/IPC
5.70	27930	8238200	PR220-11	PowerOhm
5.40 Ohms				
5.40	1200	97000	PR5F4R1K20	PowerOhm
5.40	1382	59900	PR5F4R1K38	PowerOhm
5.40	1670	55700	T5F4R1K67	PG/IPC
5.40	1670	81800	PRT5F4R1K67	PowerOhm
5.40	1749	61700	PR5F4R1K74	PowerOhm
5.40	1949	61700	PR5F4R1K94	PowerOhm
5.40	2680	182900	PRT5F4R2K68	PowerOhm
5.40	2680	185000	T5F4R2K68	PG/IPC
5.40	2856	154800	PR5F4R2K85	PowerOhm
5.40	3650	207900	PR5F4R3K65	PowerOhm
5.40	4541	444300	PR5F4R4K54	PowerOhm
5.40	5080	385200	PRT5F4R5K8	PowerOhm
5.40	5080	401000	T5F4R5K8	PG/IPC
5.40	5529	603100	PR5F4R5K52	PowerOhm
5.40	5780	169000	T5F4R5K78	PG/IPC
5.40	5780	500700	PRT5F4R5K78	PowerOhm
5.40	6998	902500	PR5F4R6K99	PowerOhm
5.40	7280	328000	T5F4R7K28	PG/IPC
5.40	7280	809200	PRT5F4R7K28	PowerOhm
5.40	8640	1540500	PR5F4R8K64	PowerOhm
5.40	12000	699000	T5F4R12K0	PG/IPC
5.40	12000	3328300	PRT5F4R12K0	PowerOhm
5.40	13500	2973600	PR5F4R13K5	PowerOhm
5.40	19440	4904100	PR5F4R19K4	PowerOhm
5.40	20300	738000	T5F4R20K3	PG/IPC
5.40	20300	5451100	PRT5F4R20K3	PowerOhm
5.40	22000	717000	T5F4R22K0	PG/IPC
5.40	22000	5451100	PRT5F4R22K0	PowerOhm
5.40	27993	3607800	PR5F4R27K9	PowerOhm
5.40	34560	6164200	PR5F4R34K5	PowerOhm
5.40	37700	2310000	T5F4R37K7	PG/IPC

Ohms	Watts	Watt Seconds	Catalog	Manufacturer
5.40	37700	9294800	PRT5F4R37K7	PowerOhm
5.40	43740	7276600	PR5F4R43K7	PowerOhm
5.40	48100	712100	PRT5F4R48K1	PowerOhm
5.40	48100	1845000	T5F4R48K1	PG/IPC
5.40	51900	712100	PRT5F4R51K9	PowerOhm
5.40	51900	1953000	T5F4R51K9	PG/IPC
5.40	54000	11877300	PR5F4R54K0	PowerOhm
5.40	104000	3444000	T5F4R104K0	PG/IPC
5.40	104000	29551700	PRT5F4R104K0	PowerOhm
5.00 Ohms				
5.00	6480	868900	PR4405-18A	PowerOhm
5.00	8000	1412100	PR4405-18	PowerOhm
5.00	12500	2775300	PR4410-18A	PowerOhm
5.00	18000	4658800	PR4410-18	PowerOhm
5.00	22848	1603773	442-18A	PG/IPC
5.00	24500	6865200	PR442-18A	PowerOhm
5.00	30978	1651395	552-20A	PG/IPC
5.00	32000	5593300	PR442-18	PowerOhm
5.00	34269	959801	442-18	PG/IPC
5.00	36125	11352000	PR552-20A	PowerOhm
5.00	46464	3891643	552-20	PG/IPC
5.00	50000	11217400	PR552-20	PowerOhm
5.00	51028	1733701	445-18A	PG/IPC
5.00	76534	3651418	445-18	PG/IPC
5.00	98000	6865200	PR5510-20	PowerOhm
5.00	98000	25630100	PR445-18	PowerOhm
4.80 Ohms				
4.80	2580	129400	PRT4F8R2K58	PowerOhm
4.80	2580	185000	T4F8R2K58	PG/IPC
4.80	4036	395900	PR4F8R4K03	PowerOhm
4.80	4590	401000	T4F8R4K59	PG/IPC
4.80	4590	500700	PRT4F8R4K59	PowerOhm
4.80	5490	169000	T4F8R5K49	PG/IPC
4.80	5490	809200	PRT4F8R5K49	PowerOhm
4.80	6220	802200	PR4F8R6K22	PowerOhm
4.80	7680	1369400	PR4F8R7K68	PowerOhm
4.80	8880	260000	T4F8R8K88	PG/IPC
4.80	8880	1674500	PRT4F8R8K88	PowerOhm
4.80	10900	359000	T4F8R10K9	PG/IPC
4.80	10900	2912200	PRT4F8R10K9	PowerOhm
4.80	19200	586000	T4F8R19K2	PG/IPC
4.80	19200	4360900	PRT4F8R19K2	PowerOhm
4.80	23520	6752000	PR4F8R23K5	PowerOhm
4.80	25800	984000	T4F8R25K8	PG/IPC
4.80	25800	6330400	PRT4F8R25K8	PowerOhm
4.80	34600	628300	PRT4F8R34K6	PowerOhm
4.80	34600	2310000	T4F8R34K6	PG/IPC
4.80	38880	6468100	PR4F8R38K8	PowerOhm
4.80	58200	3696000	T4F8R58K2	PG/IPC
4.80	58200	18507200	PRT4F8R58K2	PowerOhm
4.80	61000	3916000	T4F8R61K0	PG/IPC
4.80	61000	18507200	PRT4F8R61K0	PowerOhm
4.80	69120	17575000	PR4F8R69K1	PowerOhm
4.80	99300	6159000	T4F8R99K3	PG/IPC
4.80	99300	25969700	PRT4F8R99K3	PowerOhm
4.80	132000	8077000	T4F8R132K0	PG/IPC
4.80	132000	33527500	PRT4F8R132K0	PowerOhm

Ohms	Watts	Watt Seconds	Catalog	Manufacturer
4.50 Ohms				
4.50	1800	71600	PR2205-12A	PowerOhm
4.50	2380	133000	PR2205-12	PowerOhm
4.50	3042	168400	PR2210-12A	PowerOhm
4.50	4608	537600	PR2210-12	PowerOhm
4.50	4608	2028300	PR225-12	PowerOhm
4.50	5832	741800	PR222-12A	PowerOhm
4.50	6184	152850	222-12A	PG/IPC
4.50	8266	239950	222-12	PG/IPC
4.50	9112	1547800	PR222-12	PowerOhm
4.50	13810	660558	225-12A	PG/IPC
4.50	16200	4141200	PR225-12A	PowerOhm
4.50	20612	1425576	220-12A	PG/IPC
4.50	20715	1425576	225-12	PG/IPC
4.50	22050	6407500	PR220-12A	PowerOhm
4.50	28800	4794300	PR220-12	PowerOhm
4.50	30918	1486256	220-12	PG/IPC
4.00 Ohms				
4.00	8100	1238300	PR4405-19A	PowerOhm
4.00	10000	2378800	PR5505-21A	PowerOhm
4.00	14400	3623500	PR4405-19	PowerOhm
4.00	19600	5492100	PR5510-21A	PowerOhm
4.00	20736	2765900	PR4410-19	PowerOhm
4.00	25600	4394700	PR442-19A	PowerOhm
4.00	28207	1321116	442-19A	PG/IPC
4.00	32400	5255300	PR5510-21	PowerOhm
4.00	40000	8413000	PR442-19	PowerOhm
4.00	40000	8973900	PR552-21A	PowerOhm
4.00	42308	1386961	442-19	PG/IPC
4.00	44057	3441020	552-21A	PG/IPC
4.00	57600	14645800	PR445-19A	PowerOhm
4.00	66084	1799627	552-21	PG/IPC
3.90 Ohms				
3.90	7897	1238300	PR4405-20A	PowerOhm
3.90	14040	3623500	PR4405-20	PowerOhm
3.90	24960	4394700	PR4410-20	PowerOhm
3.90	31590	5255300	PR442-20A	PowerOhm
3.90	32736	2405659	442-20A	PG/IPC
3.90	45489	5531800	PR442-20	PowerOhm
3.90	49108	3246136	442-20	PG/IPC
3.90	62996	8013142	445-19A	PG/IPC
3.80 Ohms				
3.80	2010	105400	PR2205-13A	PowerOhm
3.80	3195	317700	PR2205-13	PowerOhm
3.80	3891	459000	PR2210-13A	PowerOhm
3.80	6080	1129600	PR2210-13	PowerOhm
3.80	7227	182571	222-13A	PG/IPC
3.80	7695	1238300	PR222-13A	PowerOhm
3.80	9500	1982300	PR222-13	PowerOhm
3.80	9788	328491	222-13	PG/IPC
3.80	16139	430346	225-13A	PG/IPC
3.80	18620	5176500	PR225-13A	PowerOhm
3.80	24089	751149	220-13A	PG/IPC
3.80	24212	1321116	225-13	PG/IPC
3.80	24320	3995200	PR225-13	PowerOhm
3.80	36138	2672955	220-13	PG/IPC
3.80	38000	8413000	PR220-13	PowerOhm

Ohms	Watts	Watt Seconds	Catalog	Manufacturer
3.30 Ohms				
3.30	1200	61000	PF3F3R1K20	PowerOhm
3.30	1876	105500	PF3F3R1K87	PowerOhm
3.30	2230	124600	PF3F3R2K23	PowerOhm
3.30	2775	317800	PF3F3R2K77	PowerOhm
3.30	3379	380400	PF3F3R3K37	PowerOhm
3.30	4299	556400	PF3F3R4K29	PowerOhm
3.30	6982	376100	PF3F3R6K98	PowerOhm
3.30	9251	512700	PF3F3R9K25	PowerOhm
3.30	11101	1197900	PF3F3R11K1	PowerOhm
3.30	13516	1530100	PF3F3R13K5	PowerOhm
3.30	21489	3595800	PF3F3R21K4	PowerOhm
3.30	24977	2541900	PF3F3R24K9	PowerOhm
3.30	38491	5071000	PF3F3R38K4	PowerOhm
3.30	47520	8390100	PF3F3R47K5	PowerOhm
3.30	75001	15984900	PF3F3R75K0	PowerOhm
3.30	106920	26362500	PF3F3R106K6	PowerOhm
3.30	150001	41191400	PF3F3R150K0	PowerOhm
3.30	214582	70836500	PF3F3R214K4	PowerOhm
2.70 Ohms				
2.70	2764	301600	PR2205-14A	PowerOhm
2.70	3499	460900	PR2205-14	PowerOhm
2.70	5467	928700	PR2210-14A	PowerOhm
2.70	9720	2588200	PR2210-14	PowerOhm
2.70	10500	521631	222-14A	PG/IPC
2.70	15750	520110	222-14	PG/IPC
2.70	17280	2259300	PR222-14	PowerOhm
2.70	21870	3941400	PR225-14A	PowerOhm
2.70	23452	1173670	225-14A	PG/IPC
2.70	35003	2164091	220-14A	PG/IPC
2.70	35178	2187360	225-14	PG/IPC
2.70	38880	8787400	PR220-14A	PowerOhm
2.70	38880	9519700	PR225-14	PowerOhm
2.60 Ohms				
2.60	12740	3882400	PR4405-21A	PowerOhm
2.60	16640	2824200	PR4405-21	PowerOhm
2.60	21060	3503500	PR4410-21A	PowerOhm
2.60	37440	9519700	PR4410-21	PowerOhm
2.60	44505	1126723	442-21A	PG/IPC
2.20	13370	316618	222-15A	PG/IPC
2.20	14080	2259300	PR222-15A	PowerOhm
2.20	20053	1603773	222-15	PG/IPC
2.20	22000	5047800	PR222-15	PowerOhm
2.20	29860	1685270	225-15A	PG/IPC
2.20	31680	8055100	PR225-15A	PowerOhm
2.20	44785	1724576	225-15	PG/IPC
2.20	49500	10656500	PR225-15	PowerOhm
2.10 Ohms				
2.10	1200	84900	PF2F1R1K20	PowerOhm
2.10	1420	83100	PF2F1R1K42	PowerOhm
2.10	1767	168000	PF2F1R1K76	PowerOhm
2.10	2151	253600	PF2F1R2K15	PowerOhm
2.10	2722	365700	PF2F1R2K72	PowerOhm
2.10	3361	599300	PF2F1R3K36	PowerOhm
2.10	4443	266100	PF2F1R4K44	PowerOhm
1.88 Ohms				
1.88	4500	1015300	PR2205-16A	PowerOhm
1.88	6480	1552900	PR2205-16	PowerOhm
1.88	8820	2588200	PR2210-16A	PowerOhm

Ohms	Watts	Watt Seconds	Catalog	Manufacturer
1.88	11520	2259300	PR2210-16	PowerOhm
1.88	14580	2476600	PR222-16A	PowerOhm
1.88	15350	782447	222-16A	PG/IPC
1.88	23026	1570711	222-16	PG/IPC
1.88	25920	6590600	PR222-16	PowerOhm
1.88	34281	2138364	225-16A	PG/IPC
1.88	35280	10068900	PR225-16A	PowerOhm
1.50 Ohms				
1.50	5400	1325600	PR2205-17A	PowerOhm
1.50	5400	4418900	PR222-17A	PowerOhm
1.50	6144	1075300	PR2210-17A	PowerOhm
1.50	7350	1941200	PR2205-17	PowerOhm
1.50	15000	3171800	PR2210-17	PowerOhm
1.50	19884	1308926	222-17A	PG/IPC

Minimum Dynamic Brake Resistance

PowerFlex Compact-class Drives

The tables in this section contain the minimum dynamic-brake resistance values for PowerFlex® compact-class drives.

Table 2 - Minimum Dynamic Break Resistance 120V...240V

Drive Normal Duty Rating	Regen DC Bus Voltage (Vd)	Minimum Ohms, External Resistors			
		PowerFlex Product			
		4 ⁽¹⁾	40 ⁽¹⁾	523/525/527	
				Min. Resistance ±10% ⁽²⁾	Resistance ±5% ⁽³⁾
120V, 0.25 Hp	395	—	—	56	91
120V, 0.5 Hp		—	48	56	91
120V, 1.0 Hp		—	48	56	91
120V, 1.5 Hp		—	48	41	91
240V, 0.25 Hp	395	—	—	56	91
240V, 0.5 Hp		—	48	56	91
240V, 1.0 Hp		60	48	56	91
240V, 2.0 Hp		60	48	41	91
240V, 3.0 Hp		48	32	32	47
240V, 5.0 Hp		32	19	18	47
240V, 7.5 Hp		—	13	16	30
240V, 10 Hp		—	10	14	30
240V, 15 Hp		—	—	14	15
240V, 20 Hp		—	—	10	15

(1) Excludes a resistor tolerance.

(2) Third-party resistors must be larger than the minimum resistance.

(3) This column lists the lowest ohmic value available for this size drive when a Rockwell Automation resistor with cat. no. AK-R2... is used. See the PowerFlex 520-series AC Drive Specifications Technical Data, publication [520-TD001](#), for compatible Rockwell Automation resistor catalog numbers.

Table 3 - Minimum Dynamic Break Resistance 400V...480V

Drive Normal Duty Rating	Regen DC Bus Voltage (V _d)	Minimum Ohms, External Resistors			
		PowerFlex Product			
		4 ⁽¹⁾	40 ⁽¹⁾	523/525/527	
				Min. Resistance ±10% ⁽²⁾	Resistance ±5% ⁽³⁾
400V, 0.4 kW 480V, 0.5 Hp	790	—	97	89	360
400V, 0.75 kW 480V, 1 Hp		121	97	89	360
400V, 1.5 kW 480V, 2 Hp		121	97	89	360
400V, 2.2 kW 480V, 3 Hp		97	97	89	360
400V, 4 kW 480V, 5 Hp		97	77	47	120
400V, 5.5 kW 480V, 7.5 Hp		—	55	47	120
400V, 7.5 kW 480V, 10 Hp		—	39	47	120
400V, 11 kW 480V, 15 Hp		—	24	43	60
400V, 15 kW 480V, 20 Hp		—	—	43	60
400V, 18.5 kW 480V, 25 Hp		—	—	27	40
400V, 22 kW 480V, 30 Hp		—	—	27	40

- (1) Excludes a resistor tolerance.
- (2) Third-party resistors must be larger than the minimum resistance.
- (3) This column lists the lowest ohmic value available for this size drive when a Rockwell Automation resistor with cat. no. AK-R2... is used. See the PowerFlex 520-series AC Drive Specifications Technical Data, publication [520-TD001](#), for compatible Rockwell Automation resistor catalog numbers.

Table 4 - Minimum Dynamic Break Resistance 600V...690V

Drive Normal Duty Rating	Regen DC Bus Voltage (V_d)	Minimum Ohms, External Resistors			
		PowerFlex Product			
		4 ⁽¹⁾	40 ⁽¹⁾	523/525/527	
				Min. Resistance $\pm 10\%$ ⁽²⁾	Resistance $\pm 5\%$ ⁽³⁾
600V, 0.5 Hp	987	—	—	112	360
600V, 1.0 Hp		—	120	112	360
600V, 2.0 Hp		—	120	112	360
600V, 3.0 Hp		—	82	112	120
600V, 5.0 Hp		—	82	86	120
600V, 7.5 Hp		—	51	59	120
600V, 10 Hp		—	51	59	120
600V, 15 Hp		—	51	59	60
600V, 20 Hp		—	—	59	60
600V, 25 Hp		—	—	53	60
600V, 30 Hp		—	—	34	40

(1) Excludes a resistor tolerance.

(2) Third-party resistors must be larger than the minimum resistance.

(3) This column lists the lowest ohmic value available for this size drive when a Rockwell Automation resistor with cat. no. AK-R2... is used. See the PowerFlex 520-series AC Drive Specifications Technical Data, publication [520-ID001](#), for compatible Rockwell Automation resistor catalog numbers.

PowerFlex Architecture-class Drives

The tables in this section contain the minimum dynamic-brake resistance values for PowerFlex architecture-class drives.

Table 5 - Minimum Dynamic Break Resistance 120V...240V

Drive Normal Duty Rating	Regen DC Bus Voltage (V _d)	Rated Continuous Power, Internal Resistors (P _{db})							Minimum Ohms, External Resistors ⁽¹⁾				
		PowerFlex 70		PowerFlex 700		PowerFlex 753/755			PowerFlex Product				
		Frame	Watts	Frame	Watts	Frame	Watts	Resistance (Ω)	70	700	753	755	755TS
240V, 0.5 Hp	395	—	—	—	—	1	50	62	—	—	39.50	39.50	—
240V, 1.0 Hp		—	—	—	—	1	50	62	—	—	39.50	39.50	—
240V, 2.0 Hp		—	—	—	—	1	50	22	—	—	26.33	26.33	—
240V, 3.0 Hp		—	—	—	—	1	50	22	—	—	15.80	15.80	—
240V, 5.0 Hp		—	—	—	—	1	50	22	—	—	15.80	15.80	—
240V, 0.5 Hp		A	48	0	50	2	50	22	30.4	35.8	15.80	15.80	—
240V, 1.0 Hp		A	48	0	50	2	50	22	30.4	35.8	15.80	15.80	—
240V, 2.0 Hp		B	28	1	50	2	50	22	30.4	35.8	15.80	15.80	—
240V, 3.0 Hp		B	40	1	50	2	50	22	30.4	35.8	15.80	15.80	—
240V, 5.0 Hp		C	40	1	50	2	50	22	27.4	29.5	11.29	11.29	—
240V, 7.5 Hp		D	36	1	50	2	50	22	20.9	22.7	11.29	11.29	—
240V, 10 Hp		D	36	2	50	—	—	—	20.9	21	15.80	15.80	—
240V, 15 Hp		—	—	—	—	—	—	—	11.2	11.2	8.30	8.30	—
240V, 20 Hp		—	—	—	—	—	—	—	9	9	7.90	7.90	—
240V, 25 Hp		—	—	—	—	—	—	—	9	9	3.95	3.95	—
240V, 30 Hp		—	—	—	—	—	—	—	—	7	3.95	3.95	—
240V, 40 Hp		—	—	—	—	—	—	—	—	4.6	1.65	1.65	—
240V, 50 Hp		—	—	—	—	—	—	—	—	4.6	1.65	1.65	—
240V, 60 Hp		—	—	—	—	—	—	—	—	2.1	1.65	1.65	—
240V, 70 Hp		—	—	—	—	—	—	—	—	2.1	—	—	—
240V, 75 Hp		—	—	—	—	—	—	—	—	—	1.65	1.65	—
240V, 100 Hp	—	—	—	—	—	—	—	—	—	1.65	1.65	—	
240V, 125 Hp	—	—	—	—	—	—	—	—	—	1.20	1.20	—	
240V, 150 Hp	—	—	—	—	—	—	—	—	—	0.82	0.82	—	
240V, 200 Hp	—	—	—	—	—	—	—	—	—	0.82	0.82	—	

(1) Excludes a resistor tolerance.

Table 6 - Minimum Dynamic Break Resistance 400V...480V

Drive Normal Duty Rating	Regen DC Bus Voltage (V _d)	Rated Continuous Power, Internal Resistors (P _{db})							Minimum Ohms, External Resistors ⁽²⁾				
		PowerFlex 70		PowerFlex 700		PowerFlex 753/755			PowerFlex Product				
		Frame	Watts	Frame	Watts	Frame	Watts	Resistance (Ω)	70	700	753	755	755TS
400V, 0.37 kW 480V, 0.5 Hp	790	A	48	0	50	—	—	—	61.7	63.1	—	—	—
400V, 0.75 kW 480V, 1.0 Hp		—	—	—	—	1	50	115	—	—	79	79	79
400V, 1.5 kW 480V, 2.0 Hp		—	—	—	—	1	50	115	—	—	79	79	79
400V, 2.2 kW 480V, 3.0 Hp		—	—	—	—	1	50	115	—	—	79	79	79
400V, 4 kW 480V, 5.0 Hp		—	—	—	—	1	50	62	—	—	52.7	52.7	52.7
400V, 5.5 kW 480V, 7.5 Hp		—	—	—	—	1	50	62	—	—	31.6	31.6	31.6
400V, 7.5 kW 480V, 10 Hp		—	—	—	—	1	50	62	—	—	31.6	31.6	31.6
400V, 0.75 kW 480V, 1.0 Hp		A	48	0	50	2	50	62	61.7	63.1	31.6	31.6	31.6
400V, 1.5 kW 480V, 2.0 Hp		A	48	0	50	2	50	62	61.7	63.1	31.6	31.6	31.6
400V, 2.2 kW 480V, 3.0 Hp		B	28	0	50	2	50	62	61.7	63.1	31.6	31.6	31.6
400V, 4 kW 480V, 5.0 Hp		B	28	0	50	2	50	62	61.7	63.1	31.6	31.6	31.6
400V, 5.5 kW 480V, 7.5 Hp		C	40	0	50	2	50	62	66.9	63.1	31.6	31.6	31.6
400V, 7.5 kW 480V, 10 Hp		C	40	1	50	2	50	62	66.9	63.1	31.6	31.6	31.6
400V, 11 kW 480V, 15 Hp		D	36	1	50	2	50	62	39.9	43.3	22.6	22.6	22.6
400V, 15 kW 480V, 20 Hp		D	36	2	50	—	—	—	27.8	40.2	31.6	31.6	31.6
400V, 18.5 kW 480V, 25 Hp		D	—	2	50	—	—	—	24.6	28.2	31.6	31.6	31.6
400V, 22 kW 480V, 30 Hp		D	—	—	—	—	—	—	25.1	21.7	16.6	16.6	16.6

Table 6 - Minimum Dynamic Brake Resistance 400V...480V (continued)

Drive Normal Duty Rating	Regen DC Bus Voltage (V _d)	Rated Continuous Power, Internal Resistors (P _{db})							Minimum Ohms, External Resistors ⁽²⁾				
		PowerFlex 70		PowerFlex 700		PowerFlex 753/755			PowerFlex Product				
		Frame	Watts	Frame	Watts	Frame	Watts	Resistance (Ω)	70	700	753	755	755TS
400V, 30 kW 480V, 40 Hp	790	—	—	—	—	—	—	—	17.9	18.7	15.8	15.8	15.8 ⁽³⁾
400V, 37 kW 480V, 50 Hp		—	—	—	—	—	—	—	18.7	18.7	15.8	15.8	15.8
400V, 37 kW 480V, 50 Hp ⁽¹⁾		—	—	—	—	—	—	—	—	—	—	—	12
400V, 37 kW 480V, 50 Hp ⁽¹⁾		—	—	—	—	—	—	—	—	—	7.9	7.9	7.9
400V, 45 kW 480V, 60 Hp		—	—	—	—	—	—	—	—	15.4	7.9	7.9	7.9
400V, 55 kW 480V, 75 Hp		—	—	—	—	—	—	—	—	9.2	7.9	7.9	7.9
400V, 55 kW 480V, 75 Hp ⁽¹⁾		—	—	—	—	—	—	—	—	—	3.3	3.3	3.3
400V, 75 kW 480V, 100 Hp		—	—	—	—	—	—	—	—	9.2	3.3	3.3	—
400V, 90 kW 480V, 125 Hp		—	—	—	—	—	—	—	—	4.4	3.3	3.3	—
400V, 110 kW 480V, 150 Hp		—	—	—	—	—	—	—	—	4.4	3.3	3.3	—
400V, 132 kW 480V, 200 Hp		—	—	—	—	—	—	—	—	3.3	3.3	3.3	—
400V, 132 kW 480V, 200 Hp ⁽¹⁾		—	—	—	—	—	—	—	—	—	2.4	2.4	2.4
400V, 160 kW 480V, 250 Hp		—	—	—	—	—	—	—	—	—	2.4	2.4	2.4
400V, 200 kW 480V, 300 Hp		—	—	—	—	—	—	—	—	—	2.4	2.4	2.4
400V, 250 kW 480V, 350 Hp		—	—	—	—	—	—	—	—	—	1.65	1.65	1.65
400V, 270 kW 480V, 400 Hp		—	—	—	—	—	—	—	—	—	1.65	1.65	1.65

- (1) IP54, NEMA/UL Type 12 (enclosure code G).
- (2) Excludes a resistor tolerance.
- (3) Available as a frame 3 IP20/IP00, NEMA/UL Open Type (enclosure code N).

Table 7 - Minimum Dynamic Break Resistance 600V...690V

Drive Normal Duty Rating	Regen DC Bus Voltage (V _d)	Rated Continuous Power, Internal Resistors (P _{db})							Minimum Ohms, External Resistors ⁽¹⁾				
		PowerFlex 70		PowerFlex 700		PowerFlex 753/755			PowerFlex Product				
		Frame	Watts	Frame	Watts	Frame	Watts	Resistance (Ω)	70	700	753	755	755TS
600V, 0.5 Hp	987	A	48	0	50	—	—	—	106.1	84	—	—	—
600V, 1 Hp		A	48	0	50	—	—	—	106.1	84	92.0 ⁽³⁾	92.0 ⁽³⁾	—
600V, 2 Hp		A	48	0	50	—	—	—	106.1	84	92.0 ⁽³⁾	92.0 ⁽³⁾	—
600V, 3 Hp		B	28	0	50	—	—	—	106.1	84	92.0 ⁽³⁾	92.0 ⁽³⁾	—
600V, 5 Hp		B	28	0	50	—	—	—	72.7	84	32.0 ⁽³⁾	32.0 ⁽³⁾	—
600V, 7.5 Hp		C	40	0	50	—	—	—	72.7	75.5	32.0 ⁽³⁾	32.0 ⁽³⁾	—
600V, 10 Hp		C	40	1	50	—	—	—	72.7	75.5	32.0 ⁽³⁾	32.0 ⁽³⁾	—
600V, 15 Hp		D	—	—	—	—	—	—	43.6	52	32.0 ⁽³⁾	32.0 ⁽³⁾	—
600V, 20 Hp		D	—	—	—	—	—	—	43.6	41.8	32.0 ⁽³⁾	32.0 ⁽³⁾	—
600V, 25 Hp		—	—	—	—	—	—	—	28.9	36.1	32.0 ⁽³⁾	32.0 ⁽³⁾	—
600V, 30 Hp		—	—	—	—	—	—	—	28.9	28.9	32.0 ⁽³⁾	32.0 ⁽³⁾	—
600V, 40 Hp		—	—	—	—	—	—	—	22.2	24.3	13.5 ⁽³⁾	13.5 ⁽³⁾	—
600V, 50 Hp		—	—	—	—	—	—	—	22.2	24.3	13.5 ⁽³⁾	13.5 ⁽³⁾	—
600V, 60 Hp		—	—	—	—	—	—	—	—	17.7	—	—	—
600V, 75 Hp		1135	—	—	—	—	—	—	—	—	18.1	—	—
600V, 100 Hp	—		—	—	—	—	—	—	—	18.1	—	—	—
600V, 125 Hp	—		—	—	—	—	—	—	—	6.3	—	—	—
600V, 150 Hp	—		—	—	—	—	—	—	—	6.3	—	—	—

Table 7 - Minimum Dynamic Break Resistance 600V...690V (continued)

Drive Normal Duty Rating	Regen DC Bus Voltage (V _d)	Rated Continuous Power, Internal Resistors (P _{db})							Minimum Ohms, External Resistors ⁽¹⁾				
		PowerFlex 70		PowerFlex 700		PowerFlex 753/755			PowerFlex Product				
		Frame	Watts	Frame	Watts	Frame	Watts	Resistance (Ω)	70	700	753	755	755TS
600V, 10 Hp 690V, 7.5 kW	1135	—	—	—	—	—	—	—	—	—	14.4 ⁽⁴⁾	14.4 ⁽⁴⁾	—
600V, 15 Hp 690V, 11 kW		—	—	—	—	—	—	—	—	—	14.4 ⁽⁴⁾	14.4 ⁽⁴⁾	—
600V, 20 Hp 690V, 15 kW		—	—	—	—	—	—	—	—	—	14.4 ⁽⁴⁾	14.4 ⁽⁴⁾	—
600V, 20 Hp 690V, 18.5 kW		—	—	—	—	—	—	—	—	—	14.4 ⁽⁴⁾	14.4 ⁽⁴⁾	—
600V, 25 Hp 690V, 22 kW		—	—	—	—	—	—	—	—	—	14.4 ⁽⁴⁾	14.4 ⁽⁴⁾	—
600V, 30 Hp 690V, 30 kW		—	—	—	—	—	—	—	—	—	14.4 ⁽⁴⁾	14.4 ⁽⁴⁾	—
600V, 40 Hp 690V, 37 kW		—	—	—	—	—	—	—	—	—	14.4 ⁽⁴⁾	14.4 ⁽⁴⁾	—
600V, 50 Hp 690V, 45 kW		—	—	—	—	—	—	—	—	18.1 ⁽²⁾	14.4 ⁽⁴⁾	14.4 ⁽⁴⁾	—
600V, 60 Hp 690V, 55 kW		—	—	—	—	—	—	—	—	18.1 ⁽²⁾	5.5 ⁽⁴⁾	5.5 ⁽⁴⁾	—
600V, 75 Hp 690V, 75 kW		—	—	—	—	—	—	—	—	18.1 ⁽²⁾	5.5 ⁽⁴⁾	5.5 ⁽⁴⁾	—
600V, 100 Hp 690V, 90 kW		—	—	—	—	—	—	—	—	18.4 ⁽²⁾	5.5 ⁽⁴⁾	5.5 ⁽⁴⁾	—
600V, 125 Hp 690V, 110 kW		—	—	—	—	—	—	—	—	6.3 ⁽²⁾	5.5 ⁽⁴⁾	5.5 ⁽⁴⁾	—
600V, 150 Hp 690V, 132 kW		—	—	—	—	—	—	—	—	6.3 ⁽²⁾	5.5 ⁽⁴⁾	5.5 ⁽⁴⁾	—
600V, 200 Hp 690V, 160 kW		—	—	—	—	—	—	—	—	—	3.8 ⁽⁴⁾	3.8 ⁽⁴⁾	—
600V, 250 Hp 690V, 200 kW		—	—	—	—	—	—	—	—	—	3.8 ⁽⁴⁾	3.8 ⁽⁴⁾	—
600V, 300 Hp 690V, 250 kW		—	—	—	—	—	—	—	—	—	3.2 ⁽⁴⁾	3.2 ⁽⁴⁾	—

- (1) Excludes a resistor tolerance.
- (2) Only 690V rating applicable.
- (3) 600V, Frames 3...5 only.
- (4) 600/900V, Frames 6 and 7 only.

Additional Resources

These documents contain additional information concerning related products from Rockwell Automation. You can view or download publications at rok.auto/literature.

Resource	Description
EtherNet/IP Network Devices User Manual, ENET-UM006	Describes how to configure and use EtherNet/IP devices to communicate on the EtherNet/IP network.
Ethernet Reference Manual, ENET-RM002	Describes basic Ethernet concepts, infrastructure components, and infrastructure features.
System Security Design Guidelines Reference Manual, SECURE-RM001	Provides guidance on how to conduct security assessments, implement Rockwell Automation products in a secure system, harden the control system, manage user access, and dispose of equipment.
UL Standards Listing for Industrial Control Products, publication CMPNTS-SR002	Assists original equipment manufacturers (OEMs) with construction of panels, to help ensure that they conform to the requirements of Underwriters Laboratories.
American Standards, Configurations, and Ratings: Introduction to Motor Circuit Design, publication IC-AT001	Provides an overview of American motor circuit design based on methods that are outlined in the NEC.
Industrial Components Preventive Maintenance, Enclosures, and Contact Ratings Specifications, publication IC-TD002	Provides a quick reference tool for Allen-Bradley industrial automation controls and assemblies.
Safety Guidelines for the Application, Installation, and Maintenance of Solid-state Control, publication SGI-1.1	Designed to harmonize with NEMA Standards Publication No. ICS 11-1987 and provides general guidelines for the application, installation, and maintenance of solid-state control in the form of individual devices or packaged assemblies incorporating solid-state components.
Industrial Automation Wiring and Grounding Guidelines, publication 1770-4.1	Provides general guidelines for installing a Rockwell Automation industrial system.
Product Certifications website, rok.auto/certifications .	Provides declarations of conformity, certificates, and other certification details.

Rockwell Automation Support

Use these resources to access support information.

Technical Support Center	Find help with how-to videos, FAQs, chat, user forums, Knowledgebase, and product notification updates.	rok.auto/support
Local Technical Support Phone Numbers	Locate the telephone number for your country.	rok.auto/phonesupport
Technical Documentation Center	Quickly access and download technical specifications, installation instructions, and user manuals.	rok.auto/techdocs
Literature Library	Find installation instructions, manuals, brochures, and technical data publications.	rok.auto/literature
Product Compatibility and Download Center (PCDC)	Download firmware, associated files (such as AOP, EDS, and DTM), and access product release notes.	rok.auto/pcdc

Documentation Feedback

Your comments help us serve your documentation needs better. If you have any suggestions on how to improve our content, complete the form at rok.auto/docfeedback.





Allen-Bradley, expanding human possibility, PowerFlex, and Rockwell Automation are trademarks of Rockwell Automation, Inc.

EtherNet/IP is a trademark of ODVA, Inc.

Trademarks not belonging to Rockwell Automation are property of their respective companies.

Rockwell Automation maintains current product environmental compliance information on its website at rok.auto/pec.

Rockwell Otomasyon Ticaret A.Ş. Kar Plaza İş Merkezi E Blok Kat:6 34752, İçerenköy, İstanbul, Tel: +90 (216) 5698400 EEE Yönetmeliğine Uygundur

Connect with us.    

rockwellautomation.com ————— expanding **human possibility**[®]

AMERICAS: Rockwell Automation, 1201 South Second Street, Milwaukee, WI 53204-2496 USA, Tel: (1) 414.382.2000, Fax: (1) 414.382.4444

EUROPE/MIDDLE EAST/AFRICA: Rockwell Automation NV, Pegasus Park, De Kleetlaan 12a, 1831 Diegem, Belgium, Tel: (32) 2 663 0600, Fax: (32) 2 663 0640

ASIA PACIFIC: Rockwell Automation, Level 14, Core F, Cyberport 3, 100 Cyberport Road, Hong Kong, Tel: (852) 2887 4788, Fax: (852) 2508 1846

UNITED KINGDOM: Rockwell Automation Ltd. Pitfield, Kiln Farm Milton Keynes, MK11 3DR, United Kingdom, Tel: (44)(1908) 838-800, Fax: (44)(1908) 261-917

Publication PFLEX-AT001M-EN-P - October 2022

Supersedes Publication PFLEX-AT001L-EN-P - September 2017

Copyright © 2022 Rockwell Automation, Inc. All rights reserved. Printed in the U.S.A.