

Overview

Finishes (continued)

GoldGalv®

The standard GoldGalv® finish is made up of a multi-step electrogalvanizing and zinc trivalent chromium process. The trivalent chromium finish is applied over the zinc, producing a chemically bonded non-porous barrier for protection from moisture and air. The .5 mil electro-plated zinc and gold trivalent chromium finish provides all of the features and protection of hexavalent chromium without the use of the chemical.

SilverGalv® (Suffix EG)

Often referred to as “zinc plated” or “electroplated zinc,” the steel and .5 mils of zinc are bonded by an electrolysis process. This is the identical process used in the Superstrut Goldgalv® finish without the numerous benefits of the gold-colored trivalent chromium conversion coat (see GoldGalv® finish for more information). Electrogalvanizing is most commonly applied to small fittings, hardware and threaded products.

Green or White Urethane Powder Coated (Suffix GR or WH)

Urethane powder resins are applied electrostatically to the steel after fabrication. Once the material is completely covered with the powder-form urethane, it proceeds through a 400° baking process for ten minutes, creating a chemical bond. This results in a minimum of 1.5 mil thickness of urethane coating, providing excellent resistance to chipping or peeling.

Pregalvanized (Suffix PG)

A zinc coating is applied by hot-dipping the steel coil at the mill prior to fabrication. Once the material is worked by roll-forming, cutting or punching, minimal protection is provided for raw edges. This weakness is typical with pregalvanized material and affects the channel section around holes, extreme ends and the edges of the “U” shape lips. Superstrut pregalvanized material is in conformance with ASTM A-525/G-90 specification standards, representing 0.90 ounces of zinc per square foot of steel. This finish is often referred to as “hot-dipped mill galvanized” or “mill galvanized.”

Hot-Dipped Galvanized (Suffix HDG)

The material is zinc coated after fabrication, providing total product protection on all surfaces. The fabricated channel or fitting is suspended and then dipped into tanks of hot zinc for a prolonged period, creating a coherent bond. The result is superior corrosion resistance as compared to pregalvanized material. Hot-dipped galvanizing is not recommended for threaded products, because the thickness of the zinc coating will often disrupt the threads. Superstrut hot-dipped galvanized is in conformance with ASTM Specifications A-123 (formerly A-386) and A-153. Superstrut channels maintain a minimum 1.5 ounces of zinc per square foot of steel or 2.5 mils (ASTM A-123, Thickness Grade 65). This finish is also referred to as “hot-dipped galvanized after fabrication.”

PVC Coated (Suffix PVC)

A polyvinyl chloride (PVC) plastic coating is fused to the channel, fitting or accessory after fabrication by immersing the part in fluidized PVC tanks. The fused-melt mixed powder PVC coating thickness is 15 mils (.015”) plus or minus five mils. PVC material is a thermoplastic and will soften in high temperature. An inherent weakness with PVC coatings occurs when field alterations are applied, such as cutting or drilling. These acts disrupt the sealed PVC product and warrant field touch-up. Thomas & Betts cannot be held responsible for field-altered PVC coated products.

Copper Plated (“T” inserted as the second digit of the part number; Example: CTL-710-2)

Plain steel proceeds through a series of rinse tanks to clean the material surface. Once cleaned, the fabricated part is etched by dipping into an acid pickle bath to prepare the surface for adhesion. Copper is electrically applied by submerging in a copper bath. To seal the finish, the product continues to a sealer tank and is then dried by forced hot air.

Black (Suffix B)

A black finish is raw steel with only a light oil finish as supplied by the steel manufacturer. There is no protection against red rust.

Stainless Steel (Suffix SS)

Superstrut channel is supplied in type 304 stainless steel when required. Type 316 stainless steel may be available upon request.

Aluminum (Suffix AL)

Superstrut channel and hardware are available in aluminum.

Warning: Load tables, charts and design criteria provided in this catalog are intended as guides only. Selection of proper product, installation intervals, erection and placement are the responsibility of the user.

Superstrut® products are intended to be used for the support and bracing of fixtures, cable, pipe and conduit. Improper use or installation may result in injury to persons or damage of property.

Material and finish specifications are subject to change without notice.



Channels

Standard Channels

Material

Channels are cold formed from hot-rolled pickled and oiled strip steel.

Material Thickness

All Series 1200 12 gauge material

All Series 1400 14 gauge material

Standard Lengths

Standard lengths for channel are 10 ft. and 20 ft.

Standard length tolerance $\pm 1/8"$.

Shorter lengths are available at a small cutting charge.

GoldGalv® hardware finish is standard for all Superstrut products. This is a multi-process finish of electro-plated zinc, followed by gold colored trivalent chromium to give excellent corrosion resistance and superior paint base. See pages B-106–B-107 for a complete description of the GoldGalv® hardware finish. GoldGalv® hardware will be furnished if no other finish is specified.

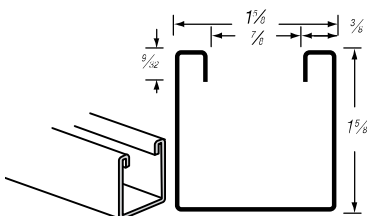

A-1200

Channel available in Solid, Half Slot, Punched, Slotted and Knockout configurations.
Wt./Ft. 1.90 lbs.

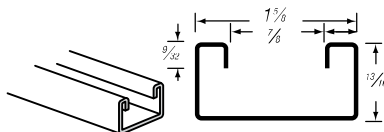

B-1200

Channel available in Solid, Half Slot, Punched and Slotted configurations.
Wt./Ft. 1.28 lbs.

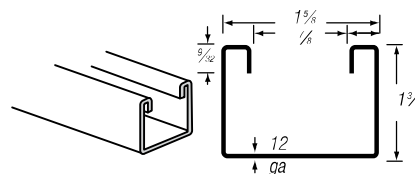

C-1200

Channel available in Solid, Half Slot and Punched configurations.
Wt./Ft. 1.70 lbs.

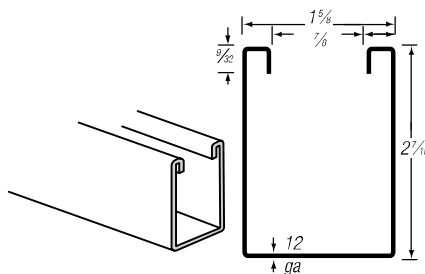

E-1200

Channel available in Solid, Half Slot and Punched configurations.
Wt./Ft. 2.47 lbs.

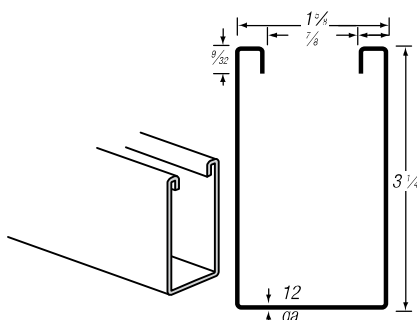

H-1200

Channel available in Solid, Half Slot and Punched configurations.
Wt./Ft. 3.05 lbs.

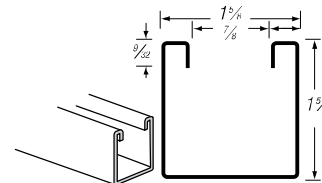

A-1400

Channel available in Solid, Half Slot, Punched, Slotted and Knockout configurations.
Wt./Ft. 1.40 lbs.

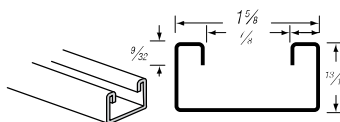

B-1400

Channel available in Solid, Half Slot, Punched and Slotted configurations.
Wt./Ft. 0.90 lbs.

Channels

Superstrut® Channels — Welding Combinations

All Superstrut® Channels are available in a variety of combinations — some are shown here.

Multiple channels are spot welded on 3" centers.

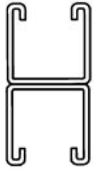

2*

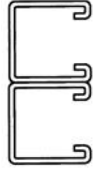

2-A

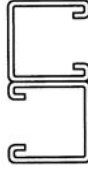

2-B

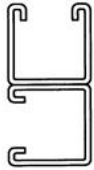

2-C



3-A



3-B

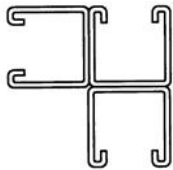

3-C

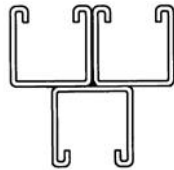

3-D

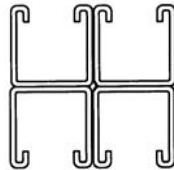

4

How to Order

10 and 20 ft. lengths — steel. Special lengths may be ordered.

Replace the 3 last digits of the regular channel catalog number with the designation of the desired combination.

Examples:

Two A-1200 channels back to back are ordered as A-1202.

Two A-1200 channels back to side are ordered as A-1202-C.

Specify desired finish or material.

**A" and "B" Series back-to-back combinations are joined using Thomas & Betts' steel rivet joining process. The riveted channel is offered in standard GoldGal®, stainless steel, painted, pre-galvanized and hot-dip galvanized finishes.

Hole Configurations

Half-Slot Channel

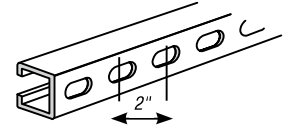

CAT. NO.	DIM. (IN.)	GA.	STD. CTN.
A-1200-HS	1½ x 1½	12	*
B-1200-HS	1½ x 1¾	12	*
C-1200-HS	1½ x 1¾	12	500
E-1200-HS	1½ x 2¼	12	500
H-1200-HS	1½ x 3¼	12	*
A-1400-HS	1½ x 1½	14	*
B-1400-HS	1½ x 1¾	14	500

¾" x 1½" slots on 2" centers.

* Standard lengths 10 ft. and 20 ft. for standard cartons.

Please consult your local T&B representative.

Slotted Channel

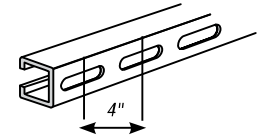

CAT. NO.	DIM. (IN.)	GA.	STD. CTN.
A-1200-S	1½ x 1½	12	*
B-1200-S	1½ x 1¾	12	*
A-1400-S	1½ x 1½	14	*
B-1400-S	1½ x 1¾	14	*

¼" x 3" slots on 4" centers.

* Standard lengths 10 ft. and 20 ft. for standard carton.

Please consult your local T&B representative.

Punched Channel

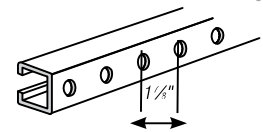

CAT. NO.	DIM. (IN.)	GA.	STD. CTN.
A-1200-P	1½ x 1½	12	500
B-1200-P	1½ x 1¾	12	500
H-1200-P	1½ x 1¾	12	500
A-1400-P	1½ x 1½	14	500
B-1400-P	1½ x 1¾	14	500

⅜" holes on 1½" centers.

Available in 10 & 20 ft. lengths.

Channel with Knockouts

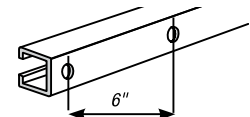

CAT. NO.	DIM. (IN.)	GA.	STD. CTN.
A-1200-KO	1½ x 1½	12	*
A-1400-KO	1½ x 1½	14	*

KO for ½" conduit.

Please consult your local T&B representative.

Standard Finish — GoldGal® brand.