

FULL SUBPANEL



ProLine subpanels are designed to provide maximum panel depth, panel size and ease of installation. Full subpanels slide into the frame on nylon glide blocks, which support the entire weight of the subpanel.

- All necessary mounting hardware is included
- Subpanels are 12 gauge (2.5-mm) steel (subpanels for double-bay enclosures 1400-mm tall or taller are 11 gauge steel), have
- Conductive subpanels are unpainted galvanized steel
- Subpanels can be mounted at nearly any depth in 25-mm increments
- Panels installed in the rearmost position in joined (ganged) enclosures provide a continuous mounting surface without requiring joining panels
- Mounting hardware attaches to the top or to the sides of the frame
- Additional Mounting Hardware (catalog number PMKPF) is available for applications requiring more support in the center or bottom of the subpanel. This is required if the enclosure will be tipped in transit or if the panel is not located at the bottom of the enclosure on the glide blocks. In addition, 3-row grid straps are required for installation unless the panel is in the rearmost position.

BULLETIN: P20

9h_FhUcTaX

Catalog Number	Material	H (mm)	H (in.)	W (mm)	W (in.)
PPF76	Steel	585	23.03	530	20.87
PPF76G	Conductive	585	23.03	530	20.87
PPF78	Steel	585	23.03	730	28.74
PPF78G	Conductive	585	23.03	730	28.74
PPF712	Steel	585	23.03	1130	44.49
PPF126G	Conductive	1085	42.72	530	20.87
PPF128G	Conductive	1085	42.72	730	28.74
PPF1212G	Conductive	1085	42.72	1130	44.49
PPF146	Steel	1285	50.59	530	20.87
PPF146G	Conductive	1285	50.59	530	20.87
PPF148	Steel	1285	50.59	730	28.74
PPF148G	Conductive	1285	50.59	730	28.74
PPF1412	Steel	1285	50.59	1130	44.49
PPF1412G	Conductive	1285	50.59	1130	44.49
PPF166	Steel	1485	58.46	530	20.87
PPF166G	Conductive	1485	58.46	530	20.87
PPF168	Steel	1485	58.46	730	28.74
PPF168G	Conductive	1485	58.46	730	28.74
PPF1612	Steel	1485	58.46	1130	44.49
PPF1612G	Conductive	1485	58.46	1130	44.49
PPF184G	Conductive	1685	66.34	430	16.93
PPF186	Steel	1685	66.34	530	20.87
PPF186G	Conductive	1685	66.34	530	20.87
PPF188	Steel	1685	66.34	730	28.74
PPF188G	Conductive	1685	66.34	730	28.74
PPF1810	Steel	1685	66.34	930	36.61
PPF1810G	Conductive	1685	66.34	930	36.61
PPF1812	Steel	1685	66.34	1130	44.49
PPF1812G	Conductive	1685	66.34	1130	44.49
PPF1816	Steel	1685	66.34	1530	60.24
PPF1816G	Plated	1685	66.34	1530	60.24
PPF1818G	Conductive	1685	66.34	1730	68.11
PPF204	Steel	1885	74.21	330	13.00
PPF204G2	Conductive	1885	74.21	330	13.00
PPF206	Steel	1885	74.21	530	20.87
PPF206G	Conductive	1885	74.21	530	20.87
PPF207	Steel	1885	74.21	630	24.80
PPF207G	Conductive	1885	74.21	630	24.80
PPF208	Steel	1885	74.21	730	28.74
PPF208G	Conductive	1885	74.21	730	28.74
PPF2010	Steel	1885	74.21	930	36.61
PPF2010G	Conductive	1885	74.21	930	36.61
PPF2012	Steel	1885	74.21	1130	44.49
PPF2012G	Conductive	1885	74.21	1130	44.49
PPF2016	Steel	1885	74.21	1530	60.24
PPF2016G	Plated	1885	74.21	1530	60.24
PPF2018G2	Conductive	1885	74.21	1730	68.11
PPF226	Steel	2085	82.09	530	20.87
PPF226G	Conductive	2085	82.09	530	20.87
PPF227	Steel	2085	82.09	630	24.80
PPF227G	Conductive	2085	82.09	630	24.80
PPF228	Steel	2085	82.09	730	28.74
PPF228G	Conductive	2085	82.09	730	28.74
PPF2210	Steel	2085	82.09	930	36.61
PPF2210G	Conductive	2085	82.09	930	36.61
PPF2212	Steel	2085	82.09	1130	44.49
PPF2212G	Conductive	2085	82.09	1130	44.49

Consult nVent HOFFMAN for delivery.

4WNgbaT_@bhagaZ; TdJ/Tx

Catalog Number	Description
PMKPF	Additional Side Mounting Hardware (see Detail in drawing)

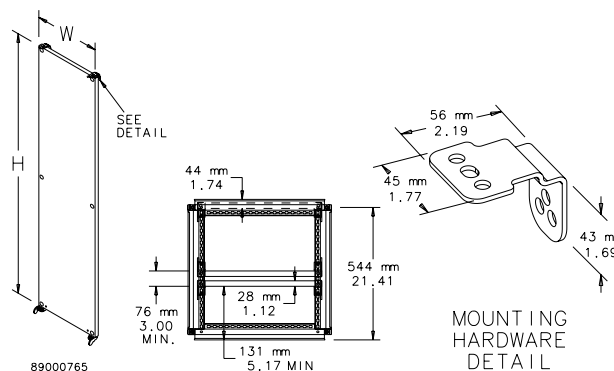

JOINING SUBPANEL



Provides a continuous panel surface in multiple bay enclosures. The joining subpanel is inserted between full subpanels of equal height. It can be installed from front or rear. Holes for grounding and mounting hardware are provided. Finish is white. Conductive joining subpanels are unpainted galvanized steel.

BULLETIN: P20

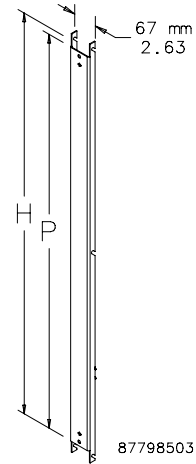
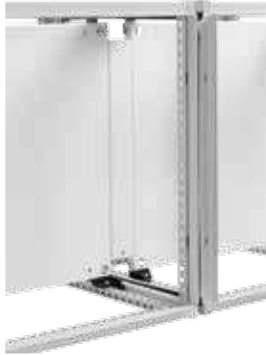

Catalog Number	Material	H (mm)	H (in.)	P (mm)	P (in.)	Fits between full subpanels
PJP7G	Conductive	585	23.03	548	21.57	PPF76, PPF78, PPF712
PJP16	Steel	1485	58.46	1448	57.00	PPF166, PPF167, PPF168, PPF1612
PJP16G	Conductive	1485	58.46	1448	57.00	PPF166, PPF167, PPF168, PPF1612
PJP18	Steel	1685	66.34	1648	64.87	PPF186, PPF187, PPF188, PPF1810, PPF1812, PPF1816
PJP18G	Conductive	1685	66.34	1648	64.87	PPF186, PPF187, PPF188, PPF1810, PPF1812, PPF1816
PJP20	Steel	1885	74.21	1848	72.75	PPF206, PPF207, PPF208, PPF2010, PPF2012, PPF2016
PJP20G	Conductive	1885	74.21	1848	72.75	PPF206, PPF207, PPF208, PPF2010, PPF2012, PPF2016
PJP22	Steel	2085	82.09	2048	80.62	PPF226, PPF227, PPF228, PPF2210, PPF2212, PPF2216
PJP22G	Conductive	2085	82.09	2048	80.62	PPF226, PPF227, PPF228, PPF2210, PPF2212, PPF2216

Consult nVent HOFFMAN for delivery.



Partial Subpanels are 12 gauge hiZZa] Wk' Vc\ Zh'dc [dj ghYZh' and are painted white. Panels can be positioned vertically in 25-mm increments and also can be positioned at any depth in 25-mm increments using the optional grid straps. Conductive subpanels are unpainted galvanized steel. All necessary mounting hardware is included.

BULLETIN: P20

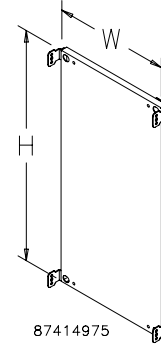

Catalog Number	Material	H (mm)	H (in.)	W (mm)	W (in.)	Fits Frame
PPP46	Steel	360	14.17	530	20.87	700 mm or taller
PPP46G	Conductive	360	14.17	530	20.87	700 mm or taller
PPP47	Steel	360	14.17	630	24.80	700 mm or taller
PPP47G	Conductive	360	14.17	630	24.80	700 mm or taller
PPP48	Steel	360	14.17	730	28.74	700 mm or taller
PPP48G	Conductive	360	14.17	730	28.74	700 mm or taller
PPP412	Steel	360	14.17	1130	44.49	700 mm or taller
PPP86	Steel	735	28.94	530	20.87	1400 mm or taller
PPP86G	Conductive	735	28.94	530	20.87	1400 mm or taller
PPP87	Steel	735	28.94	630	24.80	1400 mm or taller
PPP88	Steel	735	28.94	630	24.80	1400 mm
PPP88G	Conductive	735	28.94	730	28.74	1400 mm or taller
PPP810	Steel	735	28.94	930	36.61	1400 mm or taller
PPP96	Steel	835	32.87	530	20.87	1400 mm
PPP96G	Conductive	835	32.87	530	20.87	1400 mm or taller
PPP97	Steel	835	32.87	630	24.80	1400 mm or taller
PPP97G	Conductive	835	32.87	630	24.80	1400 mm or taller
PPP98	Steel	835	32.87	730	28.74	1400 mm or taller
PPP98G	Conductive	835	32.87	730	28.74	1400 mm or taller
PPP910	Steel	835	32.87	930	36.61	1400 mm or taller
PPP910G	Conductive	835	32.87	930	36.61	1400 mm or taller
PPP106	Steel	935	36.81	530	20.87	1400 mm or taller
PPP106G	Conductive	935	36.81	530	20.87	1400 mm or taller
PPP108	Steel	935	36.81	730	28.74	1400 mm or taller
PPP108G	Conductive	935	36.81	730	28.74	1400 mm or taller
PPP116	Steel	1035	40.75	530	20.87	1400 mm or taller
PPP116G	Conductive	1035	40.75	530	20.87	1400 mm or taller

SIDE-MOUNT SUBPANEL



Side-mounted panels can be installed on the interior sides of frames. The panel and all the hardware needed to attach the subpanels to a frame are included. Hardware is plated. Panels are 12 gauge zinc plated steel. Conductive panels are unpainted galvanized steel.

BULLETIN: P20

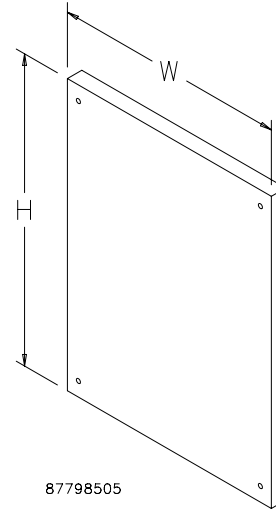

87798505

Catalog Number	Material	H (mm)	H (in.)	W (mm)	W (in.)
PPFSM76	Steel	608	23.94	447	17.60
PPFSM76G	Conductive	608	23.94	447	17.60
PPFSM145	Steel	1308	51.50	347	13.66
PPFSM145G	Conductive	1308	51.50	347	13.66
PPFSM146	Steel	1308	51.50	447	17.60
PPFSM148	Steel	1308	51.50	647	25.47
PPFSM148G	Conductive	1308	51.50	647	25.47
PPFSM164G	Conductive	1508	59.37	247	9.72
PPFSM165G	Conductive	1508	59.37	347	13.66
PPFSM166	Steel	1508	59.37	447	17.60
PPFSM166G	Conductive	1508	59.37	447	17.60
PPFSM168	Steel	1508	59.37	647	25.47
PPFSM168G	Conductive	1508	59.37	647	25.47
PPFSM169	Steel	1508	59.37	747	29.41
PPFSM169G	Conductive	1508	59.37	747	29.41
PPFSM184	Steel	1708	67.24	247	9.72
PPFSM185	Steel	1708	67.24	347	13.66
PPFSM185G	Conductive	1708	67.24	347	13.66
PPFSM186	Steel	1708	67.24	447	17.60
PPFSM186G	Conductive	1708	67.24	447	17.60
PPFSM188	Steel	1708	67.24	647	25.47
PPFSM188G	Conductive	1708	67.24	647	25.47
PPFSM189	Steel	1708	67.24	747	29.41
PPFSM189G	Conductive	1708	67.24	747	29.41
PPFSM204	Steel	1908	75.12	247	9.72
PPFSM204G	Conductive	1908	75.12	247	9.72
PPFSM205	Steel	1908	75.12	347	13.66
PPFSM205G	Conductive	1908	75.12	347	13.66
PPFSM206	Steel	1908	75.12	447	17.60
PPFSM206G	Conductive	1908	75.12	447	17.60
PPFSM208	Steel	1908	75.12	647	25.47
PPFSM208G	Conductive	1908	75.12	647	25.47
PPFSM209	Steel	1908	75.12	747	29.41
PPFSM209G	Conductive	1908	75.12	747	29.41
PPFSM225	Steel	2108	82.99	347	13.66
PPFSM225G	Conductive	2108	82.99	347	13.66
PPFSM226	Steel	2108	82.99	447	17.60
PPFSM226G	Conductive	2108	82.99	447	17.60
PPFSM228	Steel	2108	82.99	647	25.47
PPFSM228G	Conductive	2108	82.99	647	25.47
PPFSM229	Steel	2108	82.99	747	29.41
PPFSM229G	Conductive	2108	82.99	747	29.41

PANEL SUPPORT BRACE



Panel Support Braces give additional support to single- and double-bay panels in heavy loading applications and minimize the vibration created by components mounted on the panel. Braces can be installed on existing systems without removing the panel. Panel support braces are furnished in pairs. Braces are unpainted galvanized steel.

BULLETIN: P20

Catalog Number	L (mm)	L (in.)	Fits Panel Width (mm)
PSB10	911	35.87	1000
PSB12	1111	43.74	1200
PSB16	1511	59.49	1600
PSB18	1711	67.36	1800

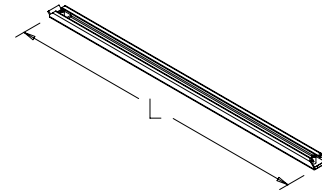

87799841

SWING-OUT PANEL



Swing-Out Panels allow a front-mounted panel to pivot out of an enclosure frame opening. This accessory includes a white panel and all the necessary hardware.

- Swing-Out Panels are available for 600-, 700- and 800-mm wide enclosures
- Panels provide 170 degrees of rotation, with capability to hinge from the right or left side
- Spring-loaded pivot post allows for easy installation
- Quarter-turn latches are provided to secure the Swing-Out Panel in the closed position

BULLETIN: P20

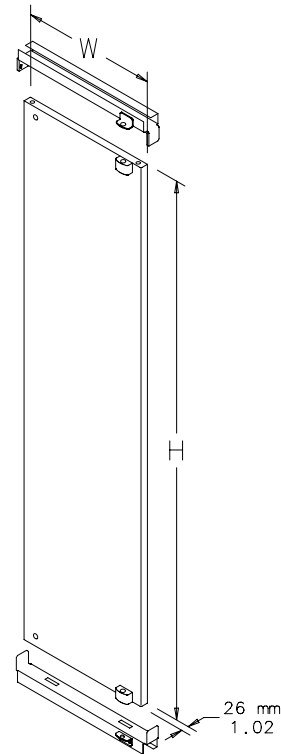

87414977

Catalog Number	H (mm)	H (in.)	W (mm)	W (in.)	Fits Frame	Fits Frame Width
PSP76	538	21.18	515	20.28	700 or taller	600
PSP146	1238	48.74	515	20.28	1400 or taller	600
PSP186	1638	64.49	515	20.28	1800 or taller	600
PSP206	1838	72.36	515	20.28	2000 or taller	600
PSP226	2038	80.24	515	20.28	2200 tall	600
PSP77	538	21.18	615	24.21	700 or taller	700
PSP147	1238	48.74	615	24.21	1400 or taller	700
PSP207	1838	72.36	615	24.21	2000 or taller	700
PSP78	538	21.18	715	28.15	700 or taller	800
PSP148	1238	48.74	715	28.15	1400 or taller	800
PSP168	1438	56.61	715	28.15	1600 or taller	800
PSP188	1638	64.49	715	28.15	1800 or taller	800
PSP208	1838	72.36	715	28.15	2000 or taller	800
PSP228	2038	80.24	715	28.15	2200 tall	800

TRANSFORMER RAILS



FEATURES

- Installed side-to-side in the frame for component mounting
- Includes four M10 clamping nuts and bolts to attach equipment to rails

SPECIFICATIONS

- Available in 600, 800, and 1200 mm lengths
- All mounting hardware included

9AF;

Plated

BULLETIN: P20

Catalog Number	Length (mm)	Length (in.)	Fits Frame Width (mm)
PTR6	534	21.02	600
PTR8	734	28.90	800
PTR12	1134	44.65	1200

APPLICATION

Transformer Rails are used to mount heavy components and transformers in the bottom of an enclosure.

GROUNDING BAR SYSTEM



APPLICATION

Three sizes of grounding bars and insulated mounting brackets are available. Bars are plated copper with M6 and M5 tapped holes to provide a common point for grounding equipment. Fits all enclosures if mounted vertically. See table for horizontal mounting.

BULLETIN: P20

Catalog Number	Description	Length mm/in.	Number of Holes and Screws M6	Number of Holes and Screws M5
PGS2K	Fits 400-mm deep frame front-to-back horizontally	200 / 7.87	3/5	10/10
PGS4K	Fits 600-mm deep frame front-to-back horizontally	400 / 15.75	9/11	20/20
PGS6K	Fits 800-mm deep frame front-to-back horizontally	600 / 23.62	15/17	30/31

INDUSTRY STANDARDS

UL Component Recognized; File No. E61997

PROLINE GROUNDING KIT



The Grounding Kit allows a ProLine or ProLine G2 enclosure to be grounded. Includes six 12-gauge wires 411 mm (16.19) long with ring terminations and M6 mounting hardware.

BULLETIN: P20

Catalog Number	Wire Size	Length Between Ring Terminals mm/in.	Ring Terminal Hole Diameter mm/in.
PGK	12 ga.	411 / 16.19	7 / .29



Grid Strap installation (side to side)



Grid strap installation (vertical and horizontal grid straps)

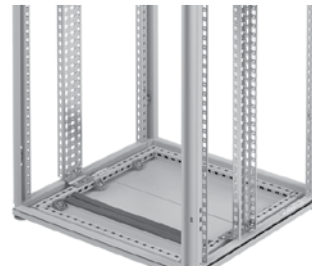

Full-height vertical grid strap

6<gYHhZb`egkYZhV`ZmWZniZchdcidj]Z`ciZgVab dj ci`h`hriZb`VazWnTj`g`h]ZY1`1]i]Z`EgIAcZ`[g/b`Z#`]Z`<gYHhZb`
 Vaul`h`ZmWZ`b`dj`ci`h`XVeWb`h`Z`h`c`]Z`^]i!`!`Yi`VcY`YZei`#6XXZ`hdgZ`hdgZ`f`j`eb`Zci`XVc`VZ`Vi`VX]ZY`Y`g`Xi`and`i]Z`<gYHhZb`
 using either cage nuts or front-loading cage nuts.

68AG8E HCE< ; G



Center Uprights are vertical channels that attach to the frame (top and bottom). Can be used in 800-, 1000-, 1200- and 1600-mm wide frames to facilitate the installation of accessories for 600-mm wide frames and 19-in. rack accessories in wider frames. The vertical hole pattern matches the vertical hole pattern in the frame. Center uprights are furnished in pairs and include mounting hardware.

BULLETIN: P20

Catalog Number	H (mm)	H (in.)	Fits Frame Height
PCU7	625	24.61	700
PCU16	1525	60.04	1600
PCU18	1725	67.91	1800
PCU20	1925	75.79	2000
PCU22	2125	83.66	2200

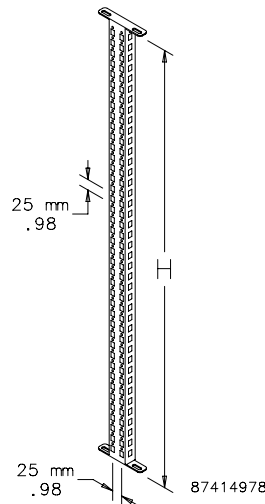

9H7??; 8< ; G1 8EG-64?: E-7 FGE 4CF

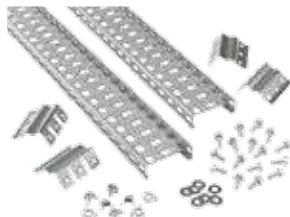

Grid Straps provide a vertical extension of the frame holes in the sides of the ProLine frame. They are sold in pairs with mounting hardware included. Vertical Grid Straps are 14 gauge plated steel. Three-row 25-mm hole spacing allows the use of cage nuts or front-loading cage nuts.

BULLETIN: P20

Catalog Number	L (mm)	L (in.)	Fits Frame Height
PGH3S7V	595	23.43	700
PGH3S14V	1295	50.98	1400
PGH3S16V	1495	58.86	1600
PGH3S18V	1695	66.73	1800
PGH3S20V	1895	74.61	2000
PGH3S22V	2095	82.48	2200

