

Kellems® Wire Management Products
 Strain Relief for Liquidtight Conduit
 Liquidtight Conduit Grips

HUBBELL

Features

- Helps prevent conduit pull-out and damage at fitting
- Reduces equipment downtime

Ordering Information

Description	Style	UPC	Catalog Number
90° Angle With Male Fitting	90 Degree	783585332017	074093545

Listings

UL Listed
 CSA Certified

Specifications

Strand	Stainless Steel
Body	Zinc plated iron
Seal	Nylon
Ferrule	Zinc plated steel
Locknut	Zinc plated steel
Insulator	Nylon

Performance

Environmental	
Flammability	UL 94-HB and UL 94-V2
Hazardous Location	Suitable for use in hazardous locations per Class I, Div. 2, Class II, Div. 1 & 2, Class III, Div. 1 & 2
Operating Temperature	-30°F to +225°F (-34°C to +107°C)

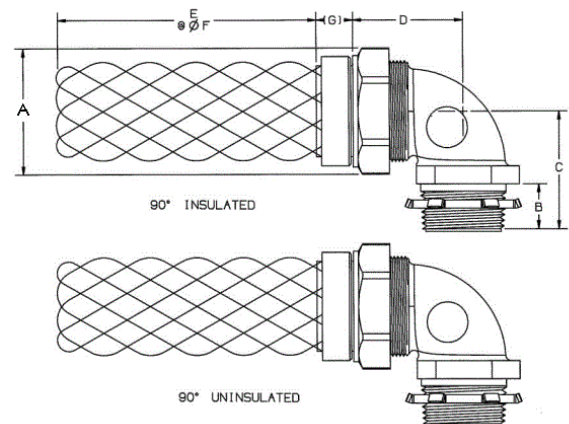

Online Resources

Customer Use Drawing
 eCatalog

Dimensions in Inches (mm)

Hubbell Wiring Device-Kellems • Hubbell Incorporated (Delaware) • 40 Waterview Drive • Shelton, CT 06484

Phone (800) 288-6000 • Fax (800) 255-1031 • Specifications subject to change without notice.

